





















Kabeleinführungen und Kabelschutz



Zeichen & Symbole

Die nachfolgenden Zeichen und Symbole helfen Ihnen bei der Orientierung in unserem Katalog und spezifizieren die genauen Produktinformationen.

Type	WISKA-Typenbezeichnung		Durchmesser Kabel unter Schirm innen
WISKA-No.	WISKA-Artikelnummer		Anzahl der Kabel
WISKA-No. RAL 3000 RD	WISKA-Artikelnummer feuerrot		Schlüsselweite
WISKA-No. RAL 7001 SG	WISKA-Artikelnummer silbergrau		Schlüsselweite 1
WISKA-No. RAL 7031 BG	WISKA-Artikelnummer blaugrau		Schlüsselweite 2
WISKA-No. RAL 7035 LG	WISKA-Artikelnummer lichtgrau	l/h	Luftdurchfluss (Liter pro Stunde, 70mbar)
WISKA-No. RAL 9001 WH	WISKA-Artikelnummer cremeweiß		Kabelverschraubung
WISKA-No. RAL 9005 BK	WISKA-Artikelnummer tiefschwarz	NW	Nennweite
	Verpackungseinheit		Breite
	Durchmesser Anschlussgewinde		Außendurchmesser
	Durchmesser Anschlussgewinde außen		Verschlussdurchmesser
	Durchmesser Anschlussgewinde innen		Durchmesser Bohrung
	Länge Anschlussgewinde		Wandstärke
TL (mm)	Gesamtlänge		Befestigungsbohrung
	Durchmesser Kabel		Eckmaß
	Durchmesser Kabel unter Schirm außen		Biegeradius

Inhalt

Kabelverschraubungen



Kunststoff-Kabelverschraubungen und Zubehör	7	KABEL- VER- SCHRAU- BUNGEN
Metall-Kabelverschraubungen und Zubehör, Messing / Edelstahl / Zink	23	KUNST- STOFF
Maritime Kabelverschraubungen und Zubehör, Messing	45	METALL
EMV-Kabelverschraubungen und Zubehör, Messing / Edelstahl	51	MARITIM
EX e / i Kabelverschraubungen und Zubehör, Kunststoff / Messing / Edelstahl	61	EMV
EX d Kabelverschraubungen und Zubehör, Messing	80	EX E/I
Railway Kabelverschraubungen (EN 45545) und Zubehör, Kunststoff / Messing / Edelstahl	87	EX D
Venting, Kunststoff / Messing / Edelstahl	99	RAILWAY
British Standard Kabelverschraubungen (BS 6121), Messing	107	BRÜCKAUS- GLEICH / VENTING
Dichtungen	111	BRITISH STANDARD

Membraneinführungen



CLIXX, MultiCLIXX, QUIXX, FLIP	119	DICH- TUNGEN
--------------------------------	-----	-----------------

CONMAXX Kabeleinführungssystem



Rahmen, Gitter, Dichtungen	123	MEMBRAN- EINFÜH- RUNGEN
CONMAXX Gland - Teilbare Verschraubungen	130	KABEL- EINFÜH- RUNGS- SYSTEM

Brace Kabelschutzsystem



BraceFITTING Wellrohrverschraubungen, Kunststoff	131	CONMAXX TEILB. VER- SCHRAU- BUNG
BraceCONDUIT Wellrohre, Kunststoff	144	KABEL- SCHUTZ
BraceFITTING Schlauchverschraubungen, Metall	153	BRACE FITTING KUNST- STOFF
BraceCONDUIT Schutzschläuche, Metall	154	BRACE CONDUIT KUNST- STOFF
BraceSLEEVE Gewebe- und Geflechtsschläuche	160	BRACE FITTING METALL
		BRACE CONDUIT METALL
		BRACE SLEEVE

UNSERE HERKUNFT. IHR VORTEIL.



1919 in Hamburg gegründet, kennen wir als Hersteller von Schiffsinstallationsmaterial das raue Klima an der Küste und die Herausforderungen für Mensch und Material. Diese extremen Bedingungen prägen seit fast einem Jahrhundert den Anspruch an unsere Produkte. Das Resultat: Alles, was wir herstellen, ist für härteste Anforderungen gemacht.

Diese Märkte vertrauen unseren Kabeleinführungen:

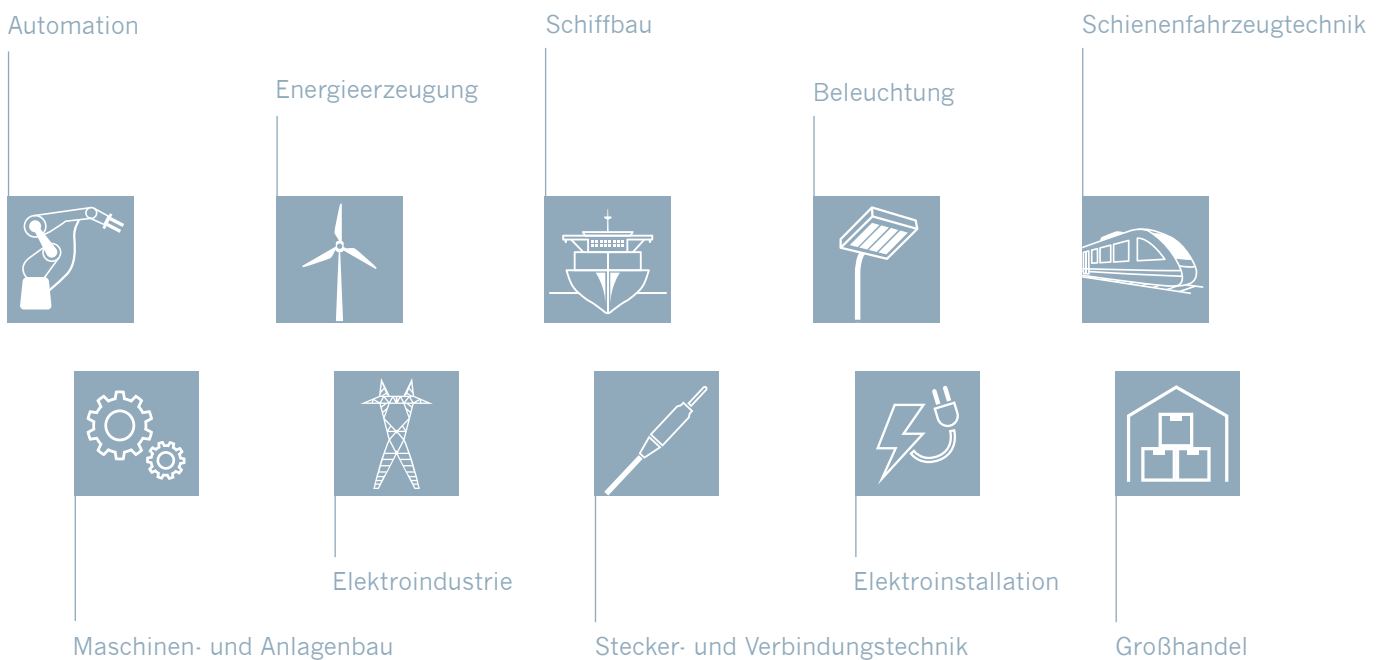

Starke Produkte aus eigener Herstellung. In jeder Kategorie.

Mit der Einführung unseres eigenen Kabelschutzsortiments und Kabeleinführungssysteme sind wir nun Ihr Vollsortimenter und Experte, immer wenn es um das Einführen von Kabeln geht! Ob Kabelverschraubungen, die atmen

können, weiche Membraneinführungen, die selbst stärkster Zugkraft standhalten oder Kabelschutz, der extremsten Temperaturen trotzt. Wenn es um Ihre Kabel geht, leisten unsere Produkte einiges und das mit höchstem Anspruch.



Kabelverschraubungen

So vielseitig wie ihre Einsatzgebiete.



Membraneinführungen

Schneller und einfacher als Kabelverschraubungen.



Kabeleinführungssystem

Bringt zusammen.
Hält zusammen.



Kabelschutz

Kabelschutz für härteste Bedingungen.

Qualität kommt von guter Partnerschaft

In Kaltenkirchen arbeiten wir in unserem Selbstverständnis als Lösungslieferant jederzeit für bestmögliche Qualitätsprodukte. Unsere Entwicklungs- und Konstruktionsabteilung sucht kundenspezielle Lösungen und arbeitet Hand in Hand mit unserer Produktionsabteilung. Hochwertige Materialien und Bedienerfreundlichkeit stehen hierbei im Fokus.

Mit einem eigenen Fertigungspark und angeschlossenen Qualitätslabor können wir sicherstellen, dass die Produkte unserem hohen Anspruch gerecht werden.

Wir verstehen uns als Partner auf Augenhöhe für Sie. Mit einem Beratungs- und Vertriebsteam und einem weltweiten Netz aus Tochtergesellschaften und Vertragspartnern beraten wir Sie jederzeit zur besten Lösung.

Unser Verständnis einer guten Zusammenarbeit beruht darauf, sich bestens zu kennen. Es geht um das Erschaffen einer Vertrauensbasis, die Sie schätzen werden, wenn alles wie am Schnürchen läuft – und noch mehr, wenn es irgendwo ruckelt.

Wir sehen es so: Miteinander gute Zahlen zu schreiben ist wichtig. Und noch wichtiger ist es, sich aufeinander verlassen zu können.



Tanja und Ronald Hoppmann, Geschäftsführer von WISKA in dritter Generation



Qualität zertifiziert





Kunststoff-Kabelverschraubungen

Bereits in den 1920er Jahren haben wir unsere erste Kunststoff-Kabelverschraubung produziert. Bis heute fertigen wir in unserer eigenen und ständig wachsenden Spritzgussfertigung nahe Hamburg technologisch hochspezialisierte Kunststoffkomponenten.

SPRINT Kabelverschraubungen, ESKV, metrisch, EN 62444



ESKV



ESKV-L

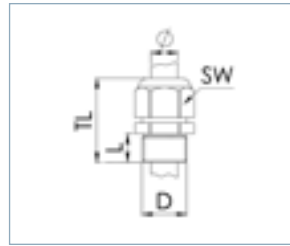

Schutzart IP68 (5 bar 30 min) / IP69
Glühdrahtprüfung 750 °C
Einsatztemperatur -40 °C - 100 °C
Material Verschraubung Polyamid, Dichtung EPDM

ESKV

Type	WISKA-No. RAL 7035 LG	WISKA-No. RAL 7001 SG	WISKA-No. RAL 9005 BK					TL (mm)	
ESKV 12	10066410	10066380	10066120	M 12x1,5	9	3 - 7	16	29 - 34	50
ESKV 16	10066411	10066381	10066121	M 16x1,5	9	4,5 - 10	20	31 - 37	50
ESKV 20	10066412	10066382	10066122	M 20x1,5	10	6 - 13	24	36 - 45	50
ESKV 20 PLUS	10061789	10061865	10061864	M 20x1,5	10	7,5 - 14	24	36 - 45	50
ESKV 25	10066413	10066383	10066123	M 25x1,5	10	9 - 17	29	38 - 47	50
ESKV 32	10066414	10066384	10066124	M 32x1,5	12	13 - 21	36	42 - 51	25
ESKV 40	10066415	10066385	10066125	M 40x1,5	12	16 - 28	46	52 - 65	10
ESKV 50	10066416	10066386	10066126	M 50x1,5	14	21 - 35	55	59 - 72	4
ESKV 63	10066417	10066387	10066127	M 63x1,5	15	34 - 48	68	64 - 78	3

ESKV-L, lang

Type	WISKA-No. RAL 7035 LG	WISKA-No. RAL 7001 SG	WISKA-No. RAL 9005 BK					TL (mm)	
ESKV-L 12	10066390	10066516	10066500	M 12x1,5	15	3 - 7	16	35 - 40	50
ESKV-L 16	10066391	10066517	10066501	M 16x1,5	15	4,5 - 10	20	37 - 43	50
ESKV-L 20	10066392	10066518	10066502	M 20x1,5	15	6 - 13	24	41 - 50	50
ESKV-L 25	10066393	10066519	10066503	M 25x1,5	15	9 - 17	29	43 - 52	50
ESKV-L 32	10066394	10066520	10066504	M 32x1,5	15	13 - 21	36	45 - 54	25
ESKV-L 40	10066395	10066521	10066505	M 40x1,5	18	16 - 28	46	58 - 71	10
ESKV-L 50	10066396	10066522	10066506	M 50x1,5	18	21 - 35	55	63 - 76	10
ESKV-L 63	10066397	10066523	10066507	M 63x1,5	18	34 - 48	68	67 - 81	10

Empfohlenes Zubehör



EMUG

RDE

EADR

BS

MFD

SPRINT Kabelverschraubungen LowTemp, ESKV LT, metrisch, EN 62444



ESKV LT



ESKV-L LT

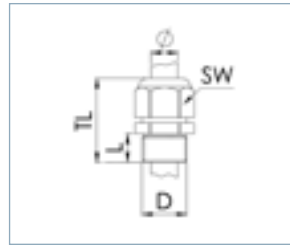

Schutzart IP68 (5 bar 30 min) / IP69
Glühdrahtprüfung 750 °C
Einsatztemperatur -60 °C - 100 °C
Material Verschraubung Polyamid, Dichtung Silikon

ESKV LT

Type	WISKA-No. RAL 7035 LG	WISKA-No. RAL 7001 SG	WISKA-No. RAL 9005 BK					TL (mm)	
ESKV 12 LT	10062763	10061917	10061490	M 12x1,5	9	3 - 7	16	29 - 34	50
ESKV 16 LT	10062777	10061957	10061499	M 16x1,5	9	4,5 - 10	20	31 - 37	50
ESKV 20 LT	10062778	10061121	10061509	M 20x1,5	10	6 - 13	24	36 - 45	50
ESKV 25 LT	10062779	10061463	10061518	M 25x1,5	10	9 - 17	29	38 - 47	50
ESKV 32 LT	10062780	10061491	10061799	M 32x1,5	12	13 - 21	36	42 - 51	25
ESKV 40 LT	10062781	10061500	10061853	M 40x1,5	12	16 - 28	46	52 - 65	10
ESKV 50 LT	10062782	10061510	10061866	M 50x1,5	14	21 - 35	55	59 - 72	4
ESKV 63 LT	10062800	10061644	10061911	M 63x1,5	15	34 - 48	68	64 - 78	3

ESKV-L LT, lang

Type	WISKA-No. RAL 7035 LG	WISKA-No. RAL 7001 SG	WISKA-No. RAL 9005 BK					TL (mm)	
ESKV-L 12 LT	10062737	10061512	10061690	M 12x1,5	15	3 - 7	16	35 - 40	50
ESKV-L 16 LT	10062738	10061691	10061855	M 16x1,5	15	4,5 - 10	20	37 - 43	50
ESKV-L 20 LT	10062739	10061860	10061868	M 20x1,5	15	6 - 13	24	41 - 50	50
ESKV-L 25 LT	10062758	10061869	10061907	M 25x1,5	15	9 - 17	29	43 - 52	50
ESKV-L 32 LT	10062759	10061908	10061919	M 32x1,5	15	13 - 21	36	45 - 54	25
ESKV-L 40 LT	10062760	10061951	10061950	M 40x1,5	18	16 - 28	46	58 - 71	10
ESKV-L 50 LT	10062761	10061494	10061493	M 50x1,5	18	21 - 35	55	63 - 76	10
ESKV-L 63 LT	10062762	10061504	10061502	M 63x1,5	18	34 - 48	68	67 - 81	10

Empfohlenes Zubehör



RDE LT

BS

EADR LT

KABEL-
VER-
SCHRAU-
BUNGEN
KUNST-
STOFF
METALL
MARTITIM
EMV
EX E/I
EX D
RAILWAY
BRÜCKEN-
GLEICH /
VENTING
BRITISH
STANDARD
DICH-
TUNGEN
MEMBRAN-
EINFÜH-
RUNGEN
MEMBRAN
KABEL-
EINFÜH-
RUNGS-
SYSTEM
CONMAXX
CONMAXX
TEILB. VER-
SCHRAU-
BUNG
KABEL-
SCHUTZ
BRACE
FITTING
KUNST-
STOFF
BRACE
CONDUIT
KUNST-
STOFF
BRACE
FITTING
METALL
BRACE
CONDUIT
METALL
BRACE
SLEEVE

SPRINT Kabelverschraubungen mit Zubehör, ESKV, metrisch, EN 62444



ESKV-SET



ESKV-RDE

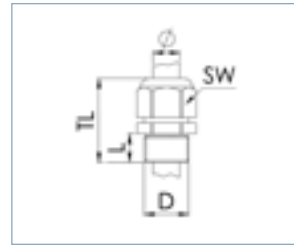

Schutzart IP68 (5 bar 30 min) / IP69
Glühdrahtprüfung 750 °C
Einsatztemperatur -40 °C · 100 °C
Material Verschraubung Polyamid, Dichtung EPDM

ESKV-SET, mit Gegenmutter

Type	WISKA-No. RAL 7035 LG				TL (mm)	
ESKV-SET 12	10066524	M 12x1,5	9	3 · 7	29 · 34	50
ESKV-SET 16	10066525	M 16x1,5	9	4,5 · 10	31 · 37	50
ESKV-SET 20	10066526	M 20x1,5	10	6 · 13	36 · 45	50
ESKV-SET 25	10066527	M 25x1,5	10	9 · 17	38 · 47	50
ESKV-SET 32	10066528	M 32x1,5	12	13 · 21	42 · 51	25
ESKV-SET 40	10066529	M 40x1,5	12	16 · 28	52 · 65	10
ESKV-SET 50	10066530	M 50x1,5	14	21 · 35	59 · 72	4
ESKV-SET 63	10066531	M 63x1,5	15	34 · 48	64 · 78	3

ESKV-RDE, mit Reduzierdichteinsatz

Type	WISKA-No. RAL 7035 LG	WISKA-No. RAL 7001 SG	WISKA-No. RAL 9005 BK				TL (mm)	
ESKV-RDE 12	10064976	10064984	10064992	M 12x1,5	9	1 · 7	29 · 34	50
ESKV-RDE 16	10064977	10064985	10064993	M 16x1,5	9	2 · 10	31 · 37	50
ESKV-RDE 20	10064978	10064986	10064994	M 20x1,5	10	4 · 13	36 · 45	50
ESKV-RDE 25	10064979	10064987	10064995	M 25x1,5	10	7 · 17	38 · 47	50
ESKV-RDE 32	10064980	10064988	10064996	M 32x1,5	12	9 · 21	42 · 51	25
ESKV-RDE 40	10064981	10064989	10064997	M 40x1,5	12	12 · 28	52 · 65	10
ESKV-RDE 50	10064982	10064990	10064998	M 50x1,5	14	16 · 35	59 · 72	4
ESKV-RDE 63	10064983	10064991	10064999	M 63x1,5	15	28 · 48	64 · 78	3

Empfohlenes Zubehör



RDE

BS

MFD

SPRINT Kabelverschraubungen flammwidrig, ESKV-F, metrisch, EN 62444



ESKV-F

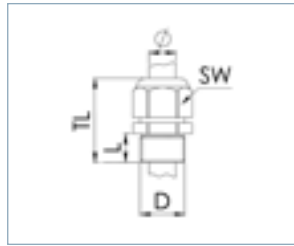

Schutzart IP68 (5 bar 30 min) / IP69
Glühdrahtprüfung 960 °C
Einsatztemperatur -40 °C - 100 °C
Material Verschraubung Polyamid, flammwidrig, Dichtung EPDM

Type	WISKA-No. RAL 7035 LG	(mm)	(mm)	(mm)	(mm)	TL (mm)	
ESKV-F 12	10064626	M 12x1,5	9	3 · 7	16	29 · 34	50
ESKV-F 16	10064627	M 16x1,5	9	4,5 · 10	20	31 · 37	50
ESKV-F 20	10064628	M 20x1,5	10	6 · 13	24	36 · 45	50
ESKV-F 25	10064629	M 25x1,5	10	9 · 17	29	38 · 47	50
ESKV-F 32	10064630	M 32x1,5	12	13 · 21	36	42 · 51	25
ESKV-F 40	10064631	M 40x1,5	12	16 · 28	46	52 · 65	10
ESKV-F 50	10064632	M 50x1,5	14	21 · 35	55	59 · 72	4
ESKV-F 63	10064633	M 63x1,5	15	34 · 48	68	64 · 78	3

Empfohlenes Zubehör



EMUF

RDE

EADR

BS

MFD

KABEL-
VER-
SCHRAU-
BUNGEN
KUNST-
STOFF
METALL
MARTIM
EMV
EX E/I
EX D
RAILWAY
BRÜCKEN-
GLEICH /
VENTING
BRITISH
STANDARD
DICH-
TUNGEN
MEMBRAN-
EINFÜH-
RUNGEN
KABEL-
EINFÜH-
RUNGS-
SYSTEM
CONMAXX
CONMAXX
TEILB. VER-
SCHRAU-
BUNG
KABEL-
SCHUTZ
BRACE
FITTING
KUNST-
STOFF
BRACE
CONDUIT
KUNST-
STOFF
BRACE
FITTING
METALL
BRACE
CONDUIT
METALL
BRACE
SLEEVE

Kabelverschraubungen mit Zugentlastung, SKV, PG

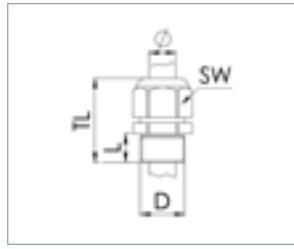

SKV



Schutzart IP68 (5 bar 30 min)
Glühdrahtprüfung 750 °C
Einsatztemperatur -40 °C - 100 °C
Material Verschraubung Polyamid, Dichtung EPDM

Type	WISKA-No. RAL 7035 LG	WISKA-No. RAL 7001 SG	WISKA-No. RAL 9005 BK	 d (mm)	 (mm)	 (mm)	 SW (mm)	TL (mm)	
SKV 7	10066400	10066001	10066191	PG 7	9	3 - 6	15	28 - 32	50
SKV 9	10066401	10066002	10066192	PG 9	9	4 - 8	19	32 - 36	50
SKV 11	10066402	10066003	10066193	PG 11	9	5 - 10	22	33 - 39	50
SKV 13,5	10066403	10066004	10066194	PG 13,5	10	6 - 12	24	35 - 41	50
SKV 16	10066404	10066005	10066195	PG 16	11	8 - 14	27	38 - 44	50
SKV 21	10066405	10066006	10066196	PG 21	11	10 - 18	33	43 - 50	25
SKV 29	10066406	10066007	10066197	PG 29	12	16 - 25	42	47 - 56	20
SKV 36	10066407	10066008	10066198	PG 36	14	22 - 32	53	56 - 65	10
SKV 42	10066408	10066009	10066199	PG 42	14	28 - 38	60	58 - 67	5
SKV 48	10066409	10101793	10066200	PG 48	15	36 - 44	65	60 - 68	4

Empfohlenes Zubehör



MUG

ADR

BS

SPRINT Kabelverschraubungen, NSKV, NPT



NSKV

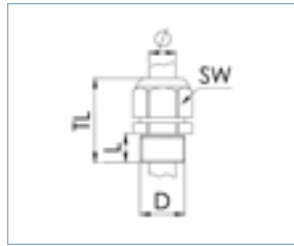

Schutzart IP68 (5 bar 30 min) / IP69
Glühdrahtprüfung 750 °C
Einsatztemperatur -40 °C - 100 °C
Material Verschraubung Polyamid, Dichtung EPDM

Type	WISKA-No. RAL 7035 LG	WISKA-No. RAL 9005 BK					TL (mm)	
NSKV 1/4	10062655	10061854	NPT 1/4"	15	3 - 7	16	33 - 38	50
NSKV 3/8	10062656	10061867	NPT 3/8"	15	4,5 - 10	20	35 - 41	50
NSKV 1/2	10062657	10061906	NPT 1/2"	15	6 - 13	24	42 - 51	50
NSKV 3/4	10062658	10061918	NPT 3/4"	15	9 - 17	29	44 - 53	50
NSKV 1	10062659	10061041	NPT 1"	15	13 - 21	36	50 - 59	25
NSKV 1 1/4	10062731	10061492	NPT 1 1/4"	18	16 - 28	46	60 - 73	10
NSKV 1 1/2	10062732	10061501	NPT 1 1/2"	18	21 - 35	55	65 - 78	4
NSKV 2	10062736	10061511	NPT 2"	18	34 - 48	68	69 - 83	3

Empfohlenes Zubehör



RDE

BS

KABEL-
VER-
SCHRAU-
BUNGEN
KUNST-
STOFF
METALL
MARTITIM
EMV
EX E/I
EX D
RAILWAY
BRÜCKEN-
GLEICH /
VENTING
BRITISH
STANDARD
DICH-
TUNGEN
MEMBRAN-
EINFÜH-
RUNGEN
MEMBRAN
KABEL-
EINFÜH-
RUNGS-
SYSTEM
CONMAXX
CONMAXX
TEILB. VER-
SCHRAU-
BUNG
KABEL-
SCHUTZ
BRACE
FITTING
KUNST-
STOFF
BRACE
CONDUIT
KUNST-
STOFF
BRACE
FITTING
METALL
BRACE
CONDUIT
METALL
BRACE
SLEEVE

SPRINT Kabelverschraubungen mit Knickschutz



ESKVS / SKVS



ESKVS-L

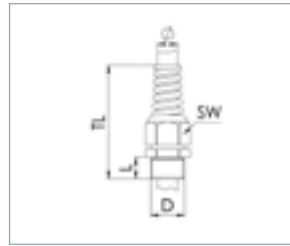

Schutzart IP68 (5 bar 30 min) / IP69
Glühdrahtprüfung 750 °C
Einsatztemperatur -40 °C - 100 °C
Material Verschraubung Polyamid, Dichtung EPDM

ESKVS, metrisch, EN 62444

Type	WISKA-No. RAL 7035 LG	WISKA-No. RAL 9005 BK					TL (mm)	
ESKVS 12	10060757	10061276	M 12x1,5	9	3 - 7	16	72 - 77	100
ESKVS 16	10060758	10061277	M 16x1,5	9	4,5 - 10	20	82 - 88	100
ESKVS 20	10060759	10061278	M 20x1,5	10	6 - 13	24	103 - 112	50
ESKVS 25	10060760	10061279	M 25x1,5	10	9 - 17	29	119 - 128	25
ESKVS 32	10060761	10061283	M 32x1,5	12	13 - 21	36	138 - 147	10

ESKVS-L, metrisch, lang, EN 62444

Type	WISKA-No. RAL 7035 LG	WISKA-No. RAL 9005 BK					TL (mm)	
ESKVS-L 12	10061210	10061215	M 12x1,5	15	3 - 7	16	78 - 83	100
ESKVS-L 16	10061211	10061216	M 16x1,5	15	4,5 - 10	20	88 - 94	100
ESKVS-L 20	10061212	10061217	M 20x1,5	15	6 - 13	24	108 - 117	50
ESKVS-L 25	10061213	10061219	M 25x1,5	15	9 - 17	29	124 - 133	25
ESKVS-L 32	10061214	10061220	M 32x1,5	15	13 - 21	36	141 - 150	10

SKVS, Zugentlastung, PG

Type	WISKA-No. RAL 7035 LG	WISKA-No. RAL 9005 BK					TL (mm)	
SKVS 7	10060615	10061871	PG 7	8	3 - 6,5	15	68	100
SKVS 9	10060616	10061872	PG 9	8	4 - 8	19	80	100
SKVS 11	10060617	10061873	PG 11	8	5 - 10	22	92	50
SKVS 13,5	10060618	10061874	PG 13,5	9	6 - 12	24	105	25
SKVS 16	10060619	10061875	PG 16	10	9 - 14	27	119	25
SKVS 21	10060620	10061876	PG 21	11	13 - 18	33	139	10

Empfohlenes Zubehör



EMUG

RDE

EADR

BS

MFD

SPRINT Kabelverschraubungen mit externer Zugentlastung, ESKVZ, metrisch, EN 62444



ESKVZ



ESKVZ-L

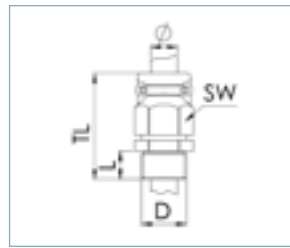

Schutzart IP68 (5 bar 30 min) / IP69
Glühdrahtprüfung 750 °C
Einsatztemperatur -40 °C - 100 °C
Material Verschraubung Polyamid, Dichtung EPDM

ESKVZ

Type	WISKA-No. RAL 7035 LG	WISKA-No. RAL 9005 BK					TL (mm)	
ESKVZ 12	10060722	10061475	M 12x1,5	9	3 - 7	16	38 - 43	100
ESKVZ 16	10060723	10061476	M 16x1,5	9	4,5 - 10	20	40 - 46	100
ESKVZ 20	10060724	10061477	M 20x1,5	10	6 - 13	24	49 - 58	50
ESKVZ 25	10060725	10061478	M 25x1,5	10	9 - 17	29	51 - 60	25
ESKVZ 32	10060727	10061479	M 32x1,5	12	13 - 21	36	57 - 66	10

ESKVZ-L, lang

Type	WISKA-No. RAL 7035 LG	WISKA-No. RAL 9005 BK					TL (mm)	
ESKVZ-L 12	10061465	10061470	M 12x1,5	15	3 - 7	16	44 - 49	100
ESKVZ-L 16	10061466	10061471	M 16x1,5	15	4,5 - 10	20	46 - 52	100
ESKVZ-L 20	10061467	10061472	M 20x1,5	15	6 - 13	24	54 - 63	50
ESKVZ-L 25	10061468	10061473	M 25x1,5	15	9 - 17	29	56 - 65	25
ESKVZ-L 32	10061469	10061474	M 32x1,5	15	13 - 21	36	60 - 69	10

Empfohlenes Zubehör



EMUG

RDE

EADR

BS

MFD

KABEL-
VER-
SCHRAU-
BUNGEN
KUNST-
STOFF
METALL
MARITIM
EMV
EX E/I
EX D
RAILWAY
BRÜCKEN-
GLEICH /
VENTING
BRITISH
STANDARD
DICH-
TUNGEN
MEMBRAN-
EINFÜH-
RUNGEN
MEMBRAN
KABEL-
EINFÜH-
RUNGS-
SYSTEM
CONMAXX
CONMAXX
TEILB. VER-
SCHRAU-
BUNG
KABEL-
SCHUTZ
BRACE
FITTING
KUNST-
STOFF
BRACE
CONDUIT
KUNST-
STOFF
BRACE
FITTING
METALL
BRACE
CONDUIT
METALL
BRACE
SLEEVE

SPRINT Gegenmuttern



EMUG



MUG

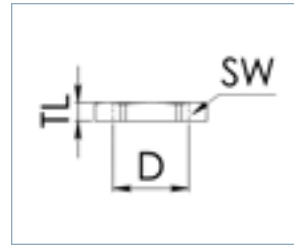

Einsatztemperatur -40 °C - 100 °C
Material Polyamid, glasfaserverstärkt

EMUG, metrisch

Type	WISKA-No. RAL 7035 LG	WISKA-No. RAL 7001 SG	WISKA-No. RAL 9005 BK			TL (mm)	
EMUG 12	10060770	10062712	10061780	M 12x1,5	18	5	100
EMUG 16	10060771	10062713	10061781	M 16x1,5	22	5	100
EMUG 20	10060772	10062714	10061782	M 20x1,5	27	5	100
EMUG 25	10060773	10062715	10061783	M 25x1,5	32	6	100
EMUG 32	10060774	10062716	10061784	M 32x1,5	40	6	100
EMUG 40	10060775	10062717	10061785	M 40x1,5	50	7	50
EMUG 50	10060776	10062718	10061786	M 50x1,5	60	7	25
EMUG 63	10060777	10062719	10061787	M 63x1,5	75	7	10

MUG, PG

Type	WISKA-No. RAL 7035 LG	WISKA-No. RAL 9005 BK			TL (mm)	
MUG 7	10060670	10060680	PG 7	19	5	100
MUG 9	10060671	10060681	PG 9	22	5	100
MUG 11	10060672	10060682	PG 11	24	5	100
MUG 13,5	10060673	10060683	PG 13,5	27	6	100
MUG 16	10060674	10060684	PG 16	30	6	100
MUG 21	10060675	10060685	PG 21	36	7	100
MUG 29	10060676	10060686	PG 29	46	7	50
MUG 36	10060677	10060687	PG 36	60	8	25
MUG 42	10060678	10060688	PG 42	65	8	25
MUG 48	10060679	10060689	PG 48	70	8	10

SPRINT Gegenmuttern flammwidrig, EMUF, metrisch



EMUF

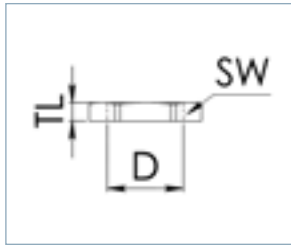

Glühdrahtprüfung 960 °C
Einsatztemperatur -40 °C - 100 °C
Material Polyamid UL94-V0

Type	WISKA-No. RAL 7035 LG	WISKA-No. RAL 9005 BK			TL (mm)	
EMUF 12	10060810	10061770	M 12x1,5	18	5	100
EMUF 16	10060811	10061771	M 16x1,5	22	5	100
EMUF 20	10060812	10061772	M 20x1,5	27	5	100
EMUF 25	10060813	10061773	M 25x1,5	32	6	100
EMUF 32	10060814	10061774	M 32x1,5	40	6	100
EMUF 40	10060815	10061775	M 40x1,5	50	7	50
EMUF 50	10060816	10061776	M 50x1,5	60	7	25
EMUF 63	10060817	10061777	M 63x1,5	75	7	10

KABEL-VER-SCHRAUBUNGEN
KUNSTSTOFF
METALL
IMARTIM
EMV
EX E/I
EX D
RAILWAY
DRUCKAUSGLEICH / VENTING
BRITISH STANDARD
DICHTUNGEN
MEMBRAN-EINFÜHRUNGEN
MEMBRAN
KABEL-EINFÜHRUNGSSYSTEM
CONMAXX
CONMAXX TEILB. VER-SCHRAUBUNG
KABEL-SCHUTZ
BRACE FITTING KUNSTSTOFF
BRACE CONDUIT KUNSTSTOFF
BRACE FITTING METALL
BRACE CONDUIT METALL
BRACE SLEEVE

Verschlusschrauben



EVSG



VSG

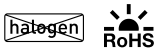
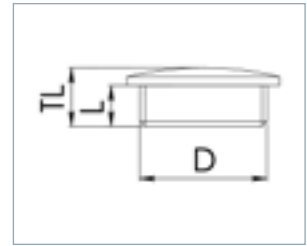

Schutzart IP56
Einsatztemperatur -40 °C - 100 °C
Material Polyamid, glasfaserverstärkt

EVSG, metrisch

Type	WISKA-No. RAL 7035 LG	WISKA-No. RAL 7001 SG	WISKA-No. RAL 9005 BK			TL (mm)	
EVSG 12	10060624	10062514	10061830	M 12x1,5	6	8	100
EVSG 16	10060625	10062515	10061831	M 16x1,5	6	9	100
EVSG 20	10060626	10062516	10061832	M 20x1,5	6	9,5	100
EVSG 25	10060627	10062517	10061833	M 25x1,5	8	11,5	100
EVSG 32	10060628	10062518	10061834	M 32x1,5	8	12	100
EVSG 40	10060629	10062519	10061835	M 40x1,5	8	13	50
EVSG 50	10060630	10062520	10061836	M 50x1,5	10	15	50
EVSG 63	10060631	10062521	10061837	M 63x1,5	12	17	25

VSG, PG

Type	WISKA-No. RAL 7035 LG			TL (mm)	
VSG 7	50060728	PG 7	6	8	100
VSG 9	50060729	PG 9	6	9	100
VSG 11	50060730	PG 11	6	9	100
VSG 13,5	50060731	PG 13,5	6	9,5	100
VSG 16	10060732	PG 16	6	9,5	100
VSG 21	50060733	PG 21	8	11	100
VSG 29	50060734	PG 29	8	12	100
VSG 36	50060735	PG 36	10	15	25
VSG 42	50060736	PG 42	10	16	25
VSG 48	50060737	PG 48	12	16	25

Empfohlenes Zubehör



EMUG / MUG

EADR / ADR

Erweiterungen



KEM



KEP

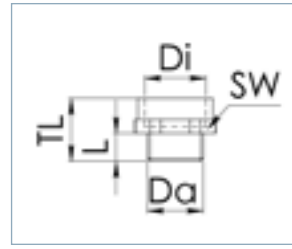

Einsatztemperatur -40 °C - 100 °C
Material Polyamid, glasfaserverstärkt

KEM, metrisch-metrisch

Type	WISKA-No. RAL 7035 LG	Da (mm)	Di (mm)	L (mm)	SW (mm)	TL (mm)	
KEM 12/16	10063570	M 12x1,5	M 16x1,5	9	20	27	100
KEM 16/20	10063571	M 16x1,5	M 20x1,5	9	24	27	100
KEM 20/25	10063572	M 20x1,5	M 25x1,5	9	29	27	100
KEM 25/32	10063573	M 25x1,5	M 32x1,5	10	36	28	100
KEM 32/40	10063574	M 32x1,5	M 40x1,5	12	46	30	50
KEM 40/50	10063575	M 40x1,5	M 50x1,5	12	55	30	25
KEM 50/63	10063576	M 50x1,5	M 63x1,5	14	68	32	5

KEP, PG-PG

Type	WISKA-No. RAL 7035 LG	Da (mm)	Di (mm)	L (mm)	SW (mm)	TL (mm)	
KEP 7/9	10063595	PG 7	PG 9	9	20	27	100
KEP 9/11	10063596	PG 9	PG 11	9	22	27	100
KEP 11/13,5	10063597	PG 11	PG 13,5	9	24	27	100
KEP 13,5/16	10063598	PG 13,5	PG 16	10	27	28	100
KEP 16/21	10063599	PG 16	PG 21	10	33	28	50
KEP 21/29	10063600	PG 21	PG 29	12	42	30	25
KEP 29/36	10063601	PG 29	PG 36	12	53	30	20
KEP 36/42	10063602	PG 36	PG 42	14	60	32	10
KEP 42/48	10063603	PG 42	PG 48	14	65	32	5

Empfohlenes Zubehör



EMUG / MUG

EADR / ADR

KABEL-
VER-
SCHRAU-
BUNGEN
KUNST-
STOFF
METALL
MARITIM
EMV
EX E/I
EX D
RAILWAY
BRÜCKAUS-
GLEICH /
VENTING
BRITISH
STANDARD
DICH-
TUNGEN
MEMBRAN-
EINFÜH-
RUNGEN
MEMBRAN
KABEL-
EINFÜH-
RUNGS-
SYSTEM
CONMAXX
CONMAXX
TEIL-
VER-
SCHRAU-
BUNG
KABEL-
SCHUTZ
BRACE
FITTING
KUNST-
STOFF
BRACE
CONDUIT
KUNST-
STOFF
BRACE
FITTING
METALL
BRACE
CONDUIT
METALL
BRACE
SLEEVE

Reduzierungen, KRM, metrisch-metrisch

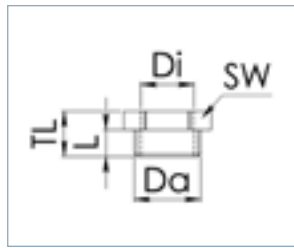

KRM



Einsatztemperatur -40 °C - 100 °C
Material Polyamid, glasfaserverstärkt

Type	WISKA-No. RAL 7035 LG	Da (mm)	Di (mm)	TL (mm)	SW (mm)	TL (mm)	
KRM 16/12	10063577	M 16x1,5	M 12x1,5	9	20	16	100
KRM 20/12	10063578	M 20x1,5	M 12x1,5	9	24	16	100
KRM 20/16	10063579	M 20x1,5	M 16x1,5	9	24	27	100
KRM 25/12	10063580	M 25x1,5	M 12x1,5	10	29	17	100
KRM 25/16	10063581	M 25x1,5	M 16x1,5	10	29	17	100
KRM 25/20	10063582	M 25x1,5	M 20x1,5	10	29	17	100
KRM 32/16	10063583	M 32x1,5	M 16x1,5	12	36	19	50
KRM 32/20	10063584	M 32x1,5	M 20x1,5	12	36	19	50
KRM 32/25	10063585	M 32x1,5	M 25x1,5	12	36	19	50
KRM 40/20	10063586	M 40x1,5	M 20x1,5	12	46	19	25
KRM 40/25	10063587	M 40x1,5	M 25x1,5	12	46	19	25
KRM 40/32	10063588	M 40x1,5	M 32x1,5	12	46	19	25
KRM 50/25	10063589	M 50x1,5	M 25x1,5	14	55	21	5
KRM 50/32	10063590	M 50x1,5	M 32x1,5	14	55	21	5
KRM 50/40	10063591	M 50x1,5	M 40x1,5	14	55	21	5
KRM 63/32	10063592	M 63x1,5	M 32x1,5	15	65	22	5
KRM 63/40	10063593	M 63x1,5	M 40x1,5	15	65	22	5
KRM 63/50	10063594	M 63x1,5	M 50x1,5	15	65	22	5



Reduzierungen, KRP, PG-PG



KRP Form A



KRP Form B

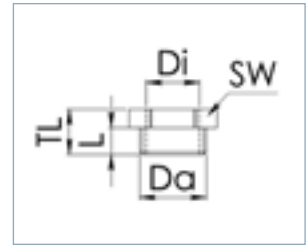
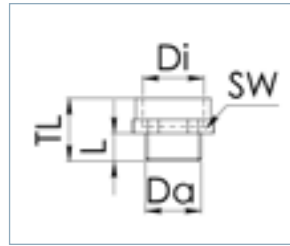

Einsatztemperatur -40 °C - 100 °C
Material Polyamid, glasfaserverstärkt

Type	WISKA-No. RAL 7035 LG	Da (mm)	Di (mm)	TL (mm)	SW (mm)	Form	TL (mm)	Form	TL (mm)
KRP 9/7	10063604	PG 9	PG 7	9	20	27	A	100	
KRP 11/7	10063605	PG 11	PG 7	9	22	16	B	100	
KRP 11/9	10063606	PG 11	PG 9	9	22	27	A	100	
KRP 13,5/7	10063607	PG 13,5	PG 7	10	24	17	B	100	
KRP 13,5/9	10063608	PG 13,5	PG 9	10	24	28	A	100	
KRP 13,5/11	10063609	PG 13,5	PG 11	10	24	28	A	100	
KRP 16/9	10063610	PG 16	PG 9	10	27	17	B	100	
KRP 16/11	10063611	PG 16	PG 11	10	27	28	A	100	
KRP 16/13,5	10063612	PG 16	PG 13,5	10	27	28	A	100	
KRP 21/11	10063613	PG 21	PG 11	12	33	19	B	100	
KRP 21/13,5	10063614	PG 21	PG 13,5	12	33	19	B	100	
KRP 21/16	10063615	PG 21	PG 16	12	33	19	B	100	
KRP 29/13,5	10063616	PG 29	PG 13,5	12	42	19	B	50	
KRP 29/16	10063617	PG 29	PG 16	12	42	19	B	50	
KRP 29/21	10063618	PG 29	PG 21	12	42	19	B	50	
KRP 36/16	10063619	PG 36	PG 16	14	53	21	B	50	
KRP 36/21	10063620	PG 36	PG 21	14	53	21	B	50	
KRP 36/29	10063621	PG 36	PG 29	14	53	21	B	10	
KRP 42/21	10063622	PG 42	PG 21	14	60	21	B	10	
KRP 42/29	10063623	PG 42	PG 29	14	60	21	B	10	
KRP 42/36	10063624	PG 42	PG 36	14	60	21	B	10	
KRP 48/29	10063625	PG 48	PG 29	15	65	22	B	10	
KRP 48/36	10063626	PG 48	PG 36	15	65	22	B	10	
KRP 48/42	10063627	PG 48	PG 42	15	65	22	B	10	

Empfohlenes Zubehör



MUG

ADR

KABEL-VER-SCHRAUBUNGEN
 KUNSTSTOFF
 METALL
 MARTITIM
 ENV
 EX E/I
 EX D
 RAILWAY
 DRUCKHAUS-GLEICH / VENTING
 BRITISH STANDARD
 DICH-TUNGEN
 MEMBRAN-EINFÜHRUNGEN
 MEMBRAN
 KABEL-EINFÜHRUNGSSYSTEM
 CONMAXX
 CONMAXX TEIL-VER-SCHRAUBUNG
 KABEL-SCHUTZ
 BRACE FITTING KUNSTSTOFF
 BRACE CONDUIT KUNSTSTOFF
 BRACE FITTING METALL
 BRACE CONDUIT METALL
 BRACE SLEEVE

Winkel 90°, EWI90, metrisch

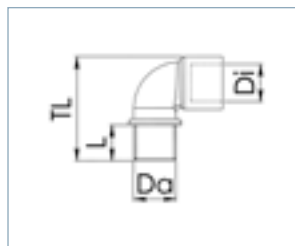

EWI 90

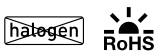

Einsatztemperatur -40 °C - 100 °C
Material Polyamid

Type	WISKA-No. RAL 7035 LG	WISKA-No. RAL 7001 SG	WISKA-No. RAL 9005 BK			TL (mm)	
EWI90 12	10064682	10064692	10064687	M 12x1,5	10	35	50
EWI90 16	10064683	10064693	10064688	M 16x1,5	8	36	50
EWI90 20	10064684	10064694	10064689	M 20x1,5	10,5	42,5	50
EWI90 25	10064685	10064695	10064690	M 25x1,5	15	54	50
EWI90 32	10064686	10064696	10064691	M 32x1,5	14	62	25

Empfohlenes Zubehör



EMUG

EADR

KABEL-VERSCRAUBUNGEN
 KUNSTSTOFF
 METALL
 MARTIM
 EWV
 EX E/I
 EX D
 RAILWAY
 DRUCKAUSGLEICH / VENTING
 BRITISH STANDARD
 DICHTUNGEN
 MEMBRAN-EINFÜHRUNGEN
 MEMBRAN
 KABEL-EINFÜHRUNGSSYSTEM
 CONNMAXX
 CONNMAXX TEIL-VERSCRAUBUNG
 KABEL-SCHUTZ
 BRACE FITTING KUNSTSTOFF
 BRACE CONDUIT KUNSTSTOFF
 BRACE FITTING METALL
 BRACE CONDUIT METALL
 BRACE SLEEVE



Metall-Kabelverschraubungen

Ob Messing, Edelstahl oder Zink - unsere Metall-Verschraubungen kommen überall dort zum Einsatz, wo anspruchsvolle Bedingungen herrschen: vom Schiffbau und Offshore, über Maschinen- und Anlagenbau, Automation bis zur Lebensmitteltechnik. Mit verschiedensten Konstruktionen, Gewindetypen, Dichtungskonzepten und Schutzarten bieten wir Ihnen die Produkte, die Sie suchen.

SPRINT Kabelverschraubungen, EMSKV, metrisch, EN 62444



EMSKV



EMSKV-L

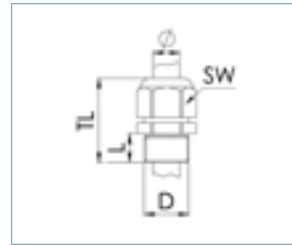

Schutzart IP68 (5 bar 30 min) / IP69
Einsatztemperatur -40 °C - 100 °C
Material Verschraubung Messing vernickelt, Klemmkäfig Polyamid, Dichtung EPDM

EMSKV

Type	WISKA-No. Ni	D (mm)	L (mm)	(mm)	SW (mm)	TL (mm)	
EMSKV 12	10065000	M 12x1,5	5	3 · 7	16	23 · 30	50
EMSKV 16	10065001	M 16x1,5	5	4,5 · 10	20	26 · 34	50
EMSKV 20	10065002	M 20x1,5	6	6 · 13	24	29 · 37	50
EMSKV 25	10065003	M 25x1,5	7	9 · 17	29	33 · 42	50
EMSKV 32	10065004	M 32x1,5	8	13 · 21	36	36 · 44	25
EMSKV 40	10065005	M 40x1,5	8	16 · 28	46	44 · 55	10
EMSKV 50	10065006	M 50x1,5	9	21 · 35	55	51 · 62	10
EMSKV 63	10065007	M 63x1,5	10	34 · 48	68	56 · 67	10
EMSKV 75	10100865	M 75x1,5	12	48 · 62	82	67 · 81	1

EMSKV-L, lang

Type	WISKA-No. Ni	D (mm)	L (mm)	(mm)	SW (mm)	TL (mm)	
EMSKV-L 12	10065008	M 12x1,5	12	3 · 7	16	30 · 37	50
EMSKV-L 16	10065009	M 16x1,5	12	4,5 · 10	20	33 · 41	50
EMSKV-L 20	10065010	M 20x1,5	12	6 · 13	24	35 · 43	50
EMSKV-L 25	10065011	M 25x1,5	12	9 · 17	29	38 · 47	50
EMSKV-L 32	10065012	M 32x1,5	15	13 · 21	36	43 · 51	25
EMSKV-L 40	10065013	M 40x1,5	15	16 · 28	46	51 · 62	10
EMSKV-L 50	10065014	M 50x1,5	15	21 · 35	55	57 · 68	10
EMSKV-L 63	10065015	M 63x1,5	15	34 · 48	68	61 · 72	10

Empfohlenes Zubehör

RDE EMMU BS MFD

SPRINT Kabelverschraubungen LowTemp, EMSKV LT, metrisch, EN 62444



EMSKV LT



EMSKV-L LT

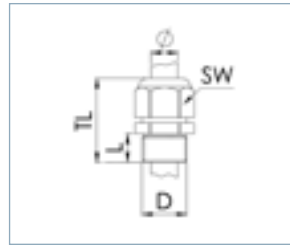

Schutzart IP68 (5 bar 30 min) / IP69
Einsatztemperatur -60 °C - 100 °C
Material Verschraubung Messing vernickelt, Klemmkäfig Polyamid, Dichtung Silikon

EMSKV LT

Type	WISKA-No. Ni	D (mm)	L (mm)	Ø (mm)	SW (mm)	TL (mm)	Icon
EMSKV 12 LT	10065800	M 12x1,5	5	3 · 7	16	23 · 30	50
EMSKV 16 LT	10065801	M 16x1,5	5	4,5 · 10	20	26 · 34	50
EMSKV 20 LT	10065802	M 20x1,5	6	6 · 13	24	29 · 37	50
EMSKV 25 LT	10065803	M 25x1,5	7	9 · 17	29	33 · 42	50
EMSKV 32 LT	10065804	M 32x1,5	8	13 · 21	36	36 · 44	25
EMSKV 40 LT	10065805	M 40x1,5	8	16 · 28	46	44 · 55	10
EMSKV 50 LT	10065806	M 50x1,5	9	21 · 35	55	51 · 62	10
EMSKV 63 LT	10065807	M 63x1,5	10	34 · 48	68	56 · 67	10

EMSKV-L LT, lang

Type	WISKA-No. Ni	D (mm)	L (mm)	Ø (mm)	SW (mm)	TL (mm)	Icon
EMSKV-L 12 LT	10065808	M 12x1,5	12	3 · 7	16	30 · 37	50
EMSKV-L 16 LT	10065809	M 16x1,5	12	4,5 · 10	20	33 · 41	50
EMSKV-L 20 LT	10065810	M 20x1,5	12	6 · 13	24	35 · 43	50
EMSKV-L 25 LT	10065811	M 25x1,5	12	9 · 17	29	38 · 47	50
EMSKV-L 32 LT	10065812	M 32x1,5	15	13 · 21	36	43 · 51	25
EMSKV-L 40 LT	10065813	M 40x1,5	15	16 · 28	46	51 · 62	10
EMSKV-L 50 LT	10065814	M 50x1,5	15	21 · 35	55	57 · 68	10
EMSKV-L 63 LT	10065815	M 63x1,5	15	34 · 48	68	61 · 72	10

Empfohlenes Zubehör

EMMU RDE LT BS

KABEL-VER-SCHRAUBUNGEN
 KUNST-STOFF
 METALL
 MARTIM
 ENV
 EX E/I
 EX D
 RAILWAY
 DRUCKAUS-GLEICH / VENTING
 BRITISH STANDARD
 DICH-TUNGEN
 MEMBRAN-EINFÜHRUNGEN
 MEMBRAN
 KABEL-EINFÜHRUNGS-SYSTEM
 CONMAXX
 CONMAXX TEIL-VER-SCHRAUBUNG
 KABEL-SCHUTZ
 BRACE FITTING KUNST-STOFF
 BRACE CONDUIT KUNST-STOFF
 BRACE FITTING METALL
 BRACE CONDUIT METALL
 BRACE SLEEVE

SPRINT Kabelverschraubungen mit Gegenmutter, EMSKV-SET, metrisch, EN 62444

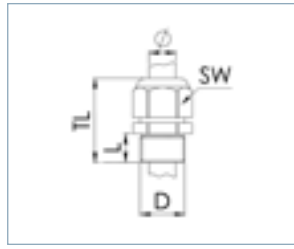

EMSKV-SET



Schutzart IP68 (5 bar 30 min) / IP69
Einsatztemperatur -40 °C - 100 °C
Material Verschraubung Messing vernickelt, Klemmkäfig Polyamid, Dichtung EPDM

Type	WISKA-No. Ni	(mm)	(mm)	(mm)	(mm)	TL (mm)	
EMSKV-SET 12	10065032	M 12x1,5	5	3 - 7	16	23 - 30	50
EMSKV-SET 16	10065033	M 16x1,5	5	4,5 - 10	20	26 - 34	50
EMSKV-SET 20	10065034	M 20x1,5	6	6 - 13	24	29 - 37	50
EMSKV-SET 25	10065035	M 25x1,5	7	9 - 17	29	33 - 42	50
EMSKV-SET 32	10065036	M 32x1,5	8	13 - 21	36	36 - 44	25
EMSKV-SET 40	10065037	M 40x1,5	8	16 - 28	46	44 - 55	10
EMSKV-SET 50	10065038	M 50x1,5	9	21 - 35	55	51 - 62	10
EMSKV-SET 63	10065039	M 63x1,5	10	34 - 48	68	56 - 67	10

Empfohlenes Zubehör



RDE

BS

MFD

Kabelverschraubungen, MSKV, PG



MSKV

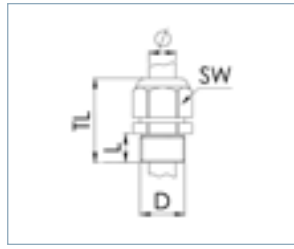

Schutzart IP68 (5 bar 30 min) / IP69
Einsatztemperatur -40 °C - 100 °C
Material Verschraubung Messing vernickelt, Klemmkäfig Polyamid, Dichtung TPV

Type	WISKA-No. Ni	D (mm)	L (mm)	Ø (mm)	SW (mm)	TL (mm)	Icon
MSKV 7	10062281	PG 7	6	3 · 6,5	14	20 · 24	50
MSKV 9	10062282	PG 9	6	4 · 8	17	21 · 25	50
MSKV 11	10062283	PG 11	6	5 · 10	20	22 · 27	50
MSKV 13,5	10062284	PG 13,5	6,5	6 · 12	22	23,5 · 29,5	50
MSKV 16	10062285	PG 16	6,5	10 · 14	24	26 · 30	50
MSKV 21	10062286	PG 21	7	13 · 18	30	29 · 34	50
MSKV 29	10062287	PG 29	8	18 · 25	40	34,5 · 41,5	25
MSKV 36	10062288	PG 36	10	22 · 32	50	38 · 48	10
MSKV 42	10062289	PG 42	12	30 · 38	57	43 · 51	10
MSKV 48	10062290	PG 48	14	34 · 44	64	43 · 53	10

Empfohlenes Zubehör



MMU

KABEL-VER-SCHRAU-BUNGEN
 KUNST-STOFF
 METALL
 MARTIM
 ENV
 EX E/I
 EX D
 RAILWAY
 DRUCKAUS-GLEICH / VENTING
 BRITISH STANDARD
 DICH-TUNGEN
 MEMBRAN-EINFÜH-RUNGEN
 KABEL-EINFÜH-RUNGS-SYSTEM
 CONMAXX
 CONMAXX-TEILB-VER-SCHRAU-BUNG
 KABEL-SCHUTZ
 BRACE FITTING KUNST-STOFF
 BRACE CONDUIT KUNST-STOFF
 BRACE FITTING METALL
 BRACE CONDUIT METALL
 BRACE SLEEVE

SPRINT Kabelverschraubungen



PMSKV





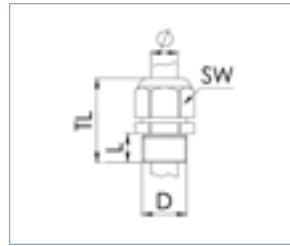

NMSKV







Schutzart IP68 (5 bar 30 min) / IP69
Einsatztemperatur -40 °C - 100 °C
Material Verschraubung Messing vernickelt, Klemmkäfig Polyamid, Dichtung EPDM

PMSKV, PG

Type	WISKA-No. Ni	 D (mm)	 (mm)	 (mm)	 SW (mm)	TL (mm)	
PMSKV 7-12	10100677	PG 7	5	3 · 7	16	23 · 30	50
PMSKV 7-16	10100678	PG 7	5	4,5 · 10	20	26 · 34	50
PMSKV 9-16	10100490	PG 9	5	4,5 · 10	20	26 · 34	50
PMSKV 11-16	10100683	PG 11	6	4,5 · 10	22	27 · 35	50
PMSKV 11-20	10100684	PG 11	6	6 · 13	24	32 · 40	50
PMSKV 13,5-20	10100685	PG 13,5	6	6 · 13	24	28 · 36	50
PMSKV 13,5-25	10100491	PG 13,5	6	9 · 17	29	33 · 42	50
PMSKV 16-20	10100686	PG 16	6	6 · 13	29	28 · 36	50
PMSKV 16-25	10100687	PG 16	6	9 · 17	29	32 · 41	50
PMSKV 21-25	10100688	PG 21	7	9 · 17	36	33 · 42	50
PMSKV 21-32	10100689	PG 21	7	13 · 21	36	39 · 47	25
PMSKV 29-40	10100690	PG 29	8	16 · 28	46	44 · 55	10
PMSKV 36-50	10100691	PG 36	9	21 · 35	55	51 · 62	10
PMSKV 42-50	10100692	PG 42	10	21 · 35	60	52 · 63	10
PMSKV 48-63	10100693	PG 48	10	34 · 48	68	56 · 67	10

NMSKV, NPT

Type	WISKA-No. Ni	 D (mm)	 (mm)	 (mm)	 SW (mm)	TL (mm)	
NMSKV 1/4	10065480	NPT 1/4"	13	3 · 7	16	33 · 40	50
NMSKV 3/8	10065481	NPT 3/8"	13	4,5 · 10	20	35 · 42	50
NMSKV 1/2	10065482	NPT 1/2"	16	6 · 13	24	38 · 45	50
NMSKV 3/4	10065483	NPT 3/4"	16	9 · 17	29	40 · 48	50
NMSKV 1	10065484	NPT 1"	20	13 · 21	36	46 · 53	25
NMSKV 1 1/4	10065485	NPT 1 1/4"	20	16 · 28	46	50 · 58	10
NMSKV 1 1/2	10065486	NPT 1 1/2"	20	21 · 35	55	51 · 62	10
NMSKV 2	10065487	NPT 2"	21	34 · 48	68	56 · 67	10

Empfohlenes Zubehör



MMU / NMMU

BS

MFD

SPRINT Kabelverschraubungen mit Knickschutz, EMSKVS, metrisch, EN 62444



EMSKVS



EMSKVS-L

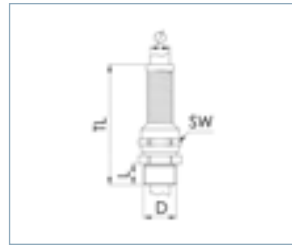

Schutzart IP68 (5 bar 30 min) / IP69
Einsatztemperatur -40 °C - 100 °C
Material Verschraubung Messing vernickelt, Klemmkäfig Polyamid, Dichtung EPDM

EMSKVS

Type	WISKA-No. Ni	D (mm)	L (mm)	(mm)	SW (mm)	TL (mm)	
EMSKVS 16	10065831	M 16x1,5	5	4,5 · 10	20	76 · 84	50
EMSKVS 20	10065832	M 20x1,5	6	6 · 13	24	96 · 104	50
EMSKVS 25	10065833	M 25x1,5	7	9 · 17	29	120 · 129	50
EMSKVS 32	10065834	M 32x1,5	8	13 · 21	36	146 · 154	25
EMSKVS 40	10065835	M 40x1,5	8	16 · 28	46	184 · 195	10
EMSKVS 50	10065836	M 50x1,5	9	21 · 35	55	231 · 242	10
EMSKVS 63	10065837	M 63x1,5	10	34 · 48	68	299 · 310	10

EMSKVS-L, lang

Type	WISKA-No. Ni	D (mm)	L (mm)	(mm)	SW (mm)	TL (mm)	
EMSKVS-L 16	10065851	M 16x1,5	12	4,5 · 10	20	83 · 91	50
EMSKVS-L 20	10065852	M 20x1,5	12	6 · 13	24	102 · 110	50
EMSKVS-L 25	10065853	M 25x1,5	12	9 · 17	29	125 · 134	50
EMSKVS-L 32	10065854	M 32x1,5	15	13 · 21	36	153 · 161	25
EMSKVS-L 40	10065855	M 40x1,5	15	16 · 28	46	191 · 202	10
EMSKVS-L 50	10065856	M 50x1,5	15	21 · 35	55	237 · 248	10
EMSKVS-L 63	10065857	M 63x1,5	15	34 · 48	68	304 · 315	10

Empfohlenes Zubehör



RDE

EMMU

BS

MFD

KABEL-
VER-
SCHRAU-
BUNGEN

KUNST-
STOFF

METALL

MARTIM

EMV

EX E/I

EX D

RAILWAY

BRÜCKEN-
GLEICH /
VENTING

BRITISH
STANDARD

DICH-
TUNGEN

MEMBRAN-
EINFÜH-
RUNGEN

MEMBRAN

KABEL-
EINFÜH-
RUNGS-
SYSTEM

CONMAXX

CONMAXX
TEIL-
SCHRAU-
BUNG

KABEL-
SCHUTZ

BRACE
FITTING
KUNST-
STOFF

BRACE
CONDUIT
KUNST-
STOFF

BRACE
FITTING
METALL

BRACE
CONDUIT
METALL

BRACE
SLEEVE

SPRINT Kabelverschraubungen mit externer Zugentlastung, EMSKVZ, metrisch, EN 62444



EMSKVZ



EMSKVZ-L

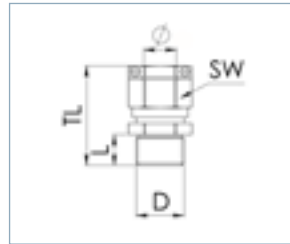

Schutzart IP68 (5 bar 30 min) / IP69
Einsatztemperatur -40 °C - 100 °C
Material Verschraubung Messing vernickelt, Klemmkäfig Polyamid, Dichtung EPDM

EMSKVZ

Type	WISKA-No. Ni					TL (mm)	
EMSKVZ 16	10065351	M 16x1,5	5	4,5 · 10	20	34 · 42	25
EMSKVZ 20	10065352	M 20x1,5	6	6 · 13	24	37 · 45	25
EMSKVZ 25	10065353	M 25x1,5	7	9 · 17	29	42 · 51	25
EMSKVZ 32	10065354	M 32x1,5	8	13 · 21	36	45 · 54	10
EMSKVZ 40	10065355	M 40x1,5	8	16 · 28	46	54 · 65	5
EMSKVZ 50	10065356	M 50x1,5	9	21 · 35	55	53 · 77	5
EMSKVZ 63	10065357	M 63x1,5	10	34 · 48	68	73 · 84	5

EMSKVZ-L, lang

Type	WISKA-No. Ni					TL (mm)	
EMSKVZ-L 16	10065860	M 16x1,5	12	4,5 · 10	20	41 · 49	25
EMSKVZ-L 20	10065861	M 20x1,5	12	6 · 13	24	43 · 51	25
EMSKVZ-L 25	10065862	M 25x1,5	12	9 · 17	29	47 · 56	25
EMSKVZ-L 32	10065863	M 32x1,5	15	13 · 21	36	53 · 61	10
EMSKVZ-L 40	10065864	M 40x1,5	15	16 · 28	46	61 · 72	5
EMSKVZ-L 50	10065865	M 50x1,5	15	21 · 35	55	69 · 80	5
EMSKVZ-L 63	10065866	M 63x1,5	15	34 · 48	68	78 · 89	5







ShotGLAND Kompressionsverschraubungen, EMCGV, metrisch, EN 62444

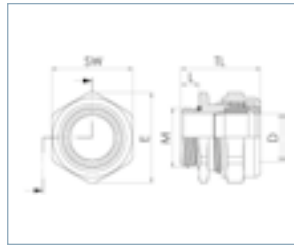





EMCGV



Schutzart IP68 (5 bar 30 min)
Einsatztemperatur -40 °C - 120 °C
Material Verschraubung Messing vernickelt, Dichtung EPDM

Type	WISKA-No. Ni	 D (mm)	 L (mm)	 L (mm)	 SW (mm)	TL (mm)	
EMCGV 8-030	10106389	M 8x1,25	5	2 - 3,3	11	15 - 18,5	50
EMCGV 8-040	10106390	M 8x1,25	5	3 - 4,3	11	15 - 18,5	50
EMCGV 8-050	10106391	M 8x1,25	5	4 - 5,3	11	15 - 18,5	50
EMCGV 12-030	10106392	M 12x1,5	6	2 - 3	18	20,5 - 24,5	50
EMCGV 12-050	10106393	M 12x1,5	6	3 - 5	18	20,5 - 24,5	50
EMCGV 12-070	10106394	M 12x1,5	6	5 - 7	18	20,5 - 24,5	50
EMCGV 12-090	10106395	M 12x1,5	6	7 - 9	18	20,5 - 24,5	50
EMCGV 16-040	10106396	M 16x1,5	6	2 - 4	22	22 - 26,5	50
EMCGV 16-060	10106397	M 16x1,5	6	4 - 6	22	22 - 26,5	50
EMCGV 16-080	10106398	M 16x1,5	6	6 - 8	22	22 - 26,5	50
EMCGV 16-100	10106399	M 16x1,5	6	8 - 10	22	22 - 26,5	50
EMCGV 16-120	10106400	M 16x1,5	6	10 - 12	22	22 - 26,5	50
EMCGV 20-060	10106401	M 20x1,5	6	4 - 6	27	22 - 26,5	50
EMCGV 20-080	10106402	M 20x1,5	6	6 - 8	27	22 - 26,5	50
EMCGV 20-100	10106403	M 20x1,5	6	8 - 10	27	22 - 26,5	50
EMCGV 20-120	10106404	M 20x1,5	6	10 - 12	27	22 - 26,5	50
EMCGV 20-140	10106405	M 20x1,5	6	12 - 14	27	22 - 26,5	50
EMCGV 20-160	10106406	M 20x1,5	6	14 - 16	27	22 - 26,5	50
EMCGV 25-080	10106407	M 25x1,5	7	6 - 8	30	23 - 28	50
EMCGV 25-100	10106408	M 25x1,5	7	8 - 10	30	23 - 28	50
EMCGV 25-120	10106409	M 25x1,5	7	10 - 12	30	23 - 28	50
EMCGV 25-140	10106410	M 25x1,5	7	12 - 14	30	23 - 28	50
EMCGV 25-160	10106411	M 25x1,5	7	14 - 16	30	23 - 28	50
EMCGV 25-170	10106412	M 25x1,5	7	15 - 17	30	23 - 28	50
EMCGV 32-110	10106413	M 32x1,5	8	9 - 11	36	24 - 28,5	25
EMCGV 32-130	10106414	M 32x1,5	8	11 - 13	36	24 - 28,5	25
EMCGV 32-150	10106415	M 32x1,5	8	13 - 15	36	24 - 28,5	25
EMCGV 32-180	10106416	M 32x1,5	8	16 - 18	36	24 - 28,5	25
EMCGV 32-200	10106417	M 32x1,5	8	18 - 20	36	24 - 28,5	25
EMCGV 32-230	10106419	M 32x1,5	8	21 - 23	36	24 - 28,5	25
EMCGV 40-180	10106420	M 40x1,5	8	16 - 18	45	24 - 28,5	10
EMCGV 40-200	10106421	M 40x1,5	8	18 - 20	45	24 - 28,5	10
EMCGV 40-220	10106422	M 40x1,5	8	20 - 22	45	24 - 28,5	10
EMCGV 40-240	10106423	M 40x1,5	8	22 - 24	45	24 - 28,5	10
EMCGV 40-260	10106424	M 40x1,5	8	24 - 26	45	24 - 28,5	10
EMCGV 40-290	10106425	M 40x1,5	8	26 - 29	45	24 - 28,5	10
EMCGV 50-280	10106426	M 50x1,5	9	26 - 28	55	25,5 - 30	10
EMCGV 50-300	10106427	M 50x1,5	9	28 - 30	55	25,5 - 30	10
EMCGV 50-320	10106428	M 50x1,5	9	30 - 32	55	25,5 - 30	10
EMCGV 50-340	10106429	M 50x1,5	9	32 - 34	55	25,5 - 30	10
EMCGV 50-360	10106430	M 50x1,5	9	34 - 36	55	25,5 - 30	10
EMCGV 50-380	10106431	M 50x1,5	9	36 - 38	55	25,5 - 30	10

Type	WISKA-No. Ni	 D (mm)	 L (mm)	 (mm)	 SW (mm)	TL (mm)	
EMCGV 63-350	10106432	M 63x1,5	10	33 · 35	68	26,5 · 31	10
EMCGV 63-380	10106433	M 63x1,5	10	35 · 38	68	26,5 · 31	10
EMCGV 63-410	10106434	M 63x1,5	10	38 · 41	68	26,5 · 31	10
EMCGV 63-440	10106435	M 63x1,5	10	41 · 44	68	26,5 · 31	10
EMCGV 63-470	10106436	M 63x1,5	10	44 · 47	68	26,5 · 31	10
EMCGV 63-490	10106437	M 63x1,5	10	47 · 49	68	26,5 · 31	10

Empfohlenes Zubehör



EMMU





ShotGLAND Kompressionsverschraubungen LowTemp, EMCGV LT, metrisch, EN 62444

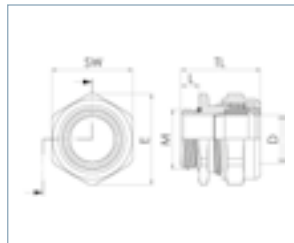





EMCGV LT



Schutzart IP68 (5 bar 30 min)
Einsatztemperatur -60 °C · 180 °C
Material Verschraubung Messing vernickelt, Dichtung Silikon

Type	WISKA-No. Ni	 D (mm)	 L (mm)	 (mm)	 SW (mm)	TL (mm)	
EMCGV 8-030 LT	10106492	M 8x1,25	5	2 · 3,3	11	15 · 18,5	50
EMCGV 8-040 LT	10106493	M 8x1,25	5	3 · 4,3	11	15 · 18,5	50
EMCGV 8-050 LT	10106494	M 8x1,25	5	4 · 5,3	11	15 · 18,5	50
EMCGV 12-030 LT	10106495	M 12x1,5	6	2 · 3	18	20,5 · 24,5	50
EMCGV 12-050 LT	10106496	M 12x1,5	6	3 · 5	18	20,5 · 24,5	50
EMCGV 12-070 LT	10106497	M 12x1,5	6	5 · 7	18	20,5 · 24,5	50
EMCGV 12-090 LT	10106498	M 12x1,5	6	7 · 9	18	20,5 · 24,5	50
EMCGV 16-040 LT	10106499	M 16x1,5	6	2 · 4	22	22 · 26,5	50
EMCGV 16-060 LT	10106500	M 16x1,5	6	4 · 6	22	22 · 26,5	50
EMCGV 16-080 LT	10106501	M 16x1,5	6	6 · 8	22	22 · 26,5	50
EMCGV 16-100 LT	10106502	M 16x1,5	6	8 · 10	22	22 · 26,5	50
EMCGV 16-120 LT	10106503	M 16x1,5	6	10 · 12	22	22 · 26,5	50
EMCGV 20-060 LT	10106504	M 20x1,5	6	4 · 6	27	22 · 26,5	50
EMCGV 20-080 LT	10106505	M 20x1,5	6	6 · 8	27	22 · 26,5	50
EMCGV 20-100 LT	10106506	M 20x1,5	6	8 · 10	27	22 · 26,5	50
EMCGV 20-120 LT	10106507	M 20x1,5	6	10 · 12	27	22 · 26,5	50
EMCGV 20-140 LT	10106508	M 20x1,5	6	12 · 14	27	22 · 26,5	50
EMCGV 20-160 LT	10106509	M 20x1,5	6	14 · 16	27	22 · 26,5	50
EMCGV 25-080 LT	10106510	M 25x1,5	7	6 · 8	30	23 · 28	50
EMCGV 25-100 LT	10106511	M 25x1,5	7	8 · 10	30	23 · 28	50
EMCGV 25-120 LT	10106512	M 25x1,5	7	10 · 12	30	23 · 28	50
EMCGV 25-140 LT	10106513	M 25x1,5	7	12 · 14	30	23 · 28	50
EMCGV 25-160 LT	10106514	M 25x1,5	7	14 · 16	30	23 · 28	50
EMCGV 25-170 LT	10106515	M 25x1,5	7	15 · 17	30	23 · 28	50

Type	WISKA-No. NI	 D (mm)	 L (mm)	 (mm)	 SW (mm)	TL (mm)	
EMCGV 32-110 LT	10106516	M 32x1,5	8	9 · 11	36	24 · 28,5	25
EMCGV 32-130 LT	10106517	M 32x1,5	8	11 · 13	36	24 · 28,5	25
EMCGV 32-150 LT	10106518	M 32x1,5	8	13 · 15	36	24 · 28,5	25
EMCGV 32-180 LT	10106519	M 32x1,5	8	16 · 18	36	24 · 28,5	25
EMCGV 32-200 LT	10106520	M 32x1,5	8	18 · 20	36	24 · 28,5	25
EMCGV 32-230 LT	10106522	M 32x1,5	8	21 · 23	36	24 · 28,5	25
EMCGV 40-180 LT	10106523	M 40x1,5	8	16 · 18	45	24 · 28,5	10
EMCGV 40-200 LT	10106524	M 40x1,5	8	18 · 20	45	24 · 28,5	10
EMCGV 40-220 LT	10106525	M 40x1,5	8	20 · 22	45	24 · 28,5	10
EMCGV 40-240 LT	10106526	M 40x1,5	8	22 · 24	45	24 · 28,5	10
EMCGV 40-260 LT	10106527	M 40x1,5	8	24 · 26	45	24 · 28,5	10
EMCGV 40-290 LT	10106528	M 40x1,5	8	26 · 29	45	24 · 28,5	10
EMCGV 50-280 LT	10106529	M 50x1,5	9	26 · 28	55	25,5 · 30	10
EMCGV 50-300 LT	10106530	M 50x1,5	9	28 · 30	55	25,5 · 30	10
EMCGV 50-320 LT	10106589	M 50x1,5	9	30 · 32	55	25,5 · 30	10
EMCGV 50-340 LT	10106531	M 50x1,5	9	32 · 34	55	25,5 · 30	10
EMCGV 50-360 LT	10106532	M 50x1,5	9	34 · 36	55	25,5 · 30	10
EMCGV 50-380 LT	10106533	M 50x1,5	9	36 · 38	55	25,5 · 30	10
EMCGV 63-350 LT	10106534	M 63x1,5	10	33 · 35	68	26,5 · 31	10
EMCGV 63-380 LT	10106535	M 63x1,5	10	35 · 38	68	26,5 · 31	10
EMCGV 63-410 LT	10106536	M 63x1,5	10	38 · 41	68	26,5 · 31	10
EMCGV 63-440 LT	10106537	M 63x1,5	10	41 · 44	68	26,5 · 31	10
EMCGV 63-470 LT	10106538	M 63x1,5	10	44 · 47	68	26,5 · 31	10
EMCGV 63-490 LT	10106539	M 63x1,5	10	47 · 49	68	26,5 · 31	10

Empfohlenes Zubehör

EMMU

 KABEL-
VER-
SCHRAU-
BUNGEN

 KUNST-
STOFF

METALL

MARTIM

ENV

EX E/I

EX D

RAILWAY

 DRUCKKAUS-
GLEICH /
VENTING

 BRITISH
STANDARD

 DICH-
TUNGEN

 MEMBRAN-
EINFÜH-
RUNGEN

MEMBRAN

 KABEL-
EINFÜH-
RUNGS-
SYSTEM

CONMAXX

 CONMAXX
TEILB. VER-
SCHRAU-
BUNG

 KABEL-
SCHUTZ

 BRACE
FITTING
KUNST-
STOFF

 BRACE
CONDUIT
KUNST-
STOFF

 BRACE
FITTING
METALL

 BRACE
CONDUIT
METALL

 BRACE
SLEEVE

SPRINT Gegenmuttern



EMMU



MMU



NMMU

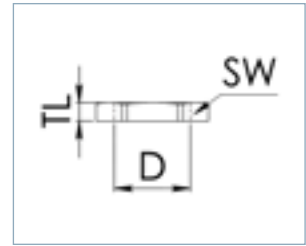

Material Messing vernickelt

EMMU, metrisch

Type	WISKA-No. Ni			TL (mm)	
EMMU 8	10106828	M 8x1,25	11	2,5	100
EMMU 12	10063141	M 12x1,5	15	2,8	100
EMMU 16	10063142	M 16x1,5	19	2,8	100
EMMU 20	10063143	M 20x1,5	24	3	100
EMMU 25	10063144	M 25x1,5	30	3,5	100
EMMU 32	10063145	M 32x1,5	36	4	100
EMMU 40	10063146	M 40x1,5	46	5	50
EMMU 50	10063147	M 50x1,5	60	5	50
EMMU 63	10063148	M 63x1,5	70	6	50
EMMU 75	10101777	M 75x1,5	80	8	1

MMU, PG

Type	WISKA-No. Ni			TL (mm)	
MMU 7	10062141	PG 7	15	2,8	100
MMU 9	10062142	PG 9	18	2,8	100
MMU 11	10062143	PG 11	21	3	100
MMU 13,5	10062144	PG 13,5	23	3	100
MMU 16	10062145	PG 16	26	3	100
MMU 21	10062146	PG 21	32	3,5	100
MMU 29	10062147	PG 29	41	4	100
MMU 36	10062148	PG 36	51	5	100
MMU 42	10062149	PG 42	60	5	50
MMU 48	10062150	PG 48	64	5	50

NMMU, NPT

Type	WISKA-No. Ni			TL (mm)	
NMMU 1/4	10100972	NPT 1/4"	18	4	100
NMMU 3/8	10100973	NPT 3/8"	21	4	100
NMMU 1/2	10100974	NPT 1/2"	26	5,5	100
NMMU 3/4	10100975	NPT 3/4"	32	5,5	100
NMMU 1	10100976	NPT 1"	41	7	100
NMMU 1 1/4	10100977	NPT 1 1/4"	51	7	50
NMMU 1 1/2	10100978	NPT 1 1/2"	60	7	50
NMMU 2	10100979	NPT 2"	70	7	50

Verschlusschrauben



EMVS / MVS



EMVS-L



EMVS-ORD

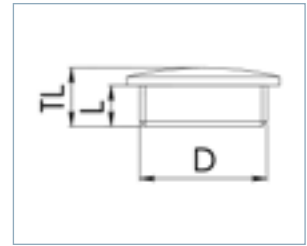

Schutzart
Hinweis
Material

IP54
mit O-Ring IP66 / IP68
Messing vernickelt

EMVS, metrisch

Type	WISKA-No. Ni			TL (mm)	
EMVS 12	10063151	M 12x1,5	5	7,5	100
EMVS 16	10063152	M 16x1,5	5	8	100
EMVS 20	10063153	M 20x1,5	6,5	9,5	100
EMVS 25	10063154	M 25x1,5	7	11	100
EMVS 32	10063155	M 32x1,5	8	12	50
EMVS 40	10063156	M 40x1,5	8,5	13	50
EMVS 50	10063157	M 50x1,5	9	15	25
EMVS 63	10063158	M 63x1,5	10	16	10

EMVS-L, lang, metrisch

Type	WISKA-No. Ni			TL (mm)	
EMVS-L 12	10065072	M 12x1,5	13	16	100
EMVS-L 16	10065073	M 16x1,5	13	16	100
EMVS-L 20	10065074	M 20x1,5	13	16	100
EMVS-L 25	10065075	M 25x1,5	14	18	100
EMVS-L 32	10065076	M 32x1,5	14,5	18,5	50
EMVS-L 40	10065077	M 40x1,5	14,5	19,5	50
EMVS-L 50	10065078	M 50x1,5	15,5	21	25
EMVS-L 63	10065079	M 63x1,5	16,5	22,5	10

MVS, PG

Type	WISKA-No. Ni			TL (mm)	
MVS 7	10062151	PG 7	5	8	100
MVS 9	10062152	PG 9	6	9	100
MVS 11	10062153	PG 11	6	9	100
MVS 13,5	10062154	PG 13,5	6,5	9,5	100
MVS 16	10062155	PG 16	6,5	9,5	100
MVS 21	10062156	PG 21	7	10,5	100
MVS 29	10062157	PG 29	8	12	50
MVS 36	10062158	PG 36	9	14	50
MVS 42	10062159	PG 42	10	14,5	25
MVS 48	10062160	PG 48	10	14,5	25

KABEL-
VER-
SCHRAU-
BUNGENKUNST-
STOFF

METALL

MARTITIM

EMV

EX E/I

EX D

RAILWAY

DRUCKAUS-
GLEICH /
VENTINGBRITISH
STANDARDDICH-
TUNGENMEMBRAN-
EINFÜH-
RUNGEN



MEMBRAN

KABEL-
EINFÜH-
RUNGS-
SYSTEM

CONMAXX

CONMAXX
TEILB. VER-
SCHRAU-
BUNGKABEL-
SCHUTZBRACE
FITTING
KUNST-
STOFFBRACE
FITTING
METALLBRACE
CONDUIT
METALLBRACE
SLEEVE

EMVS-ORD, mit montiertem O-Ring, metrisch

Type	WISKA-No. Ni			TL (mm)	
EMVS-ORD 12	10065080	M 12x1,5	5	7,5	100
EMVS-ORD 16	10065081	M 16x1,5	5	8	100
EMVS-ORD 20	10065082	M 20x1,5	6,5	9,5	100
EMVS-ORD 25	10065083	M 25x1,5	7	11	100
EMVS-ORD 32	10065084	M 32x1,5	8	12	50
EMVS-ORD 40	10065085	M 40x1,5	8,5	13	50
EMVS-ORD 50	10065086	M 50x1,5	9	15	25
EMVS-ORD 63	10065087	M 63x1,5	10	16	10

Empfohlenes Zubehör



EMMU / MMU ORD-E

Erweiterungen









MEM MEP







Material Messing vernickelt

MEM, metrisch-metrisch

Type	WISKA-No. Ni				TL (mm)	
MEM 12/16	10063953	M 12x1,5	M 16x1,5	5	15	100
MEM 16/20	10063954	M 16x1,5	M 20x1,5	5	17	100
MEM 20/25	10063955	M 20x1,5	M 25x1,5	6	19	50
MEM 25/32	10063956	M 25x1,5	M 32x1,5	7	21	50
MEM 32/40	10063957	M 32x1,5	M 40x1,5	8	24	50
MEM 40/50	10063958	M 40x1,5	M 50x1,5	8	31	25
MEM 50/63	10063959	M 50x1,5	M 63x1,5	9	31	10

MEP, PG-PG

Type	WISKA-No. Ni				TL (mm)	
MEP 7 · 9	10062191	PG 7	PG 9	5	15	100
MEP 9 · 11	10062192	PG 9	PG 11	6	16,5	100
MEP 9 · 13,5	10062193	PG 9	PG 13,5	6	17,5	100
MEP 11 · 13,5	10062194	PG 11	PG 13,5	6	17,5	100
MEP 11 · 16	10062195	PG 11	PG 16	6	18,5	100
MEP 11 · 21	10062196	PG 11	PG 21	6	21	100
MEP 13,5 · 16	10062197	PG 13,5	PG 16	6,5	19	100
MEP 13,5 · 21	10062198	PG 13,5	PG 21	6,5	21	100
MEP 16 · 21	10062199	PG 16	PG 21	6,5	21	100
MEP 16 · 29	10062200	PG 16	PG 29	7	23	50
MEP 21 · 29	10062201	PG 21	PG 29	7	23	50
MEP 29 · 36	10062202	PG 29	PG 36	8	27,5	25
MEP 36 · 42	10062203	PG 36	PG 42	9	31	25
MEP 42 · 48	10062204	PG 42	PG 48	10	33	10

Empfohlenes Zubehör



EMMU / MMU ORD-E

Reduzierungen







MRM MRP







Material Messing vernickelt

MRM, metrisch-metrisch

Type	WISKA-No. Ni				TL (mm)	
MRM 16/12	10063940	M 16x1,5	M 12x1,5	5	8	100
MRM 20/12	10063941	M 20x1,5	M 12x1,5	6	8,5	100
MRM 20/16	10063942	M 20x1,5	M 16x1,5	6	8,5	100
MRM 25/16	10063943	M 25x1,5	M 16x1,5	7	10	50
MRM 25/20	10063944	M 25x1,5	M 20x1,5	7	10	100
MRM 32/20	10063945	M 32x1,5	M 20x1,5	8	11,5	25
MRM 32/25	10063946	M 32x1,5	M 25x1,5	8	11,5	50
MRM 40/25	10063947	M 40x1,5	M 25x1,5	8	11,5	25
MRM 40/32	10063948	M 40x1,5	M 32x1,5	8	11,5	25
MRM 50/32	10063949	M 50x1,5	M 32x1,5	9	12,5	10
MRM 50/40	10063950	M 50x1,5	M 40x1,5	9	12,5	25
MRM 63/40	10063951	M 63x1,5	M 40x1,5	10	14	10
MRM 63/50	10063952	M 63x1,5	M 50x1,5	10	14	10

KABEL-VER-SCHRAUBUNGEN
KUNST-STOFF
METALL
MARTIM
EMV
EX E/I
EX D
RAILWAY
DRUCKAUSGLEICH / VENTING
BRITISH STANDARD
DICHTUNGEN
MEMBRAN-EINFÜHRUNGEN
KABEL-EINFÜHRUNGSSYSTEM
CONMAXX
CONMAXX TEIL-VER-SCHRAUBUNG
KABEL-SCHUTZ
BRACE FITTING KUNST-STOFF
BRACE CONDUIT KUNST-STOFF
BRACE FITTING METALL
BRACE CONDUIT METALL
BRACE SLEEVE

MRP, PG-PG

Type	WISKA-No. Ni				TL (mm)	
MRP 9 · 7	10062161	PG 9	PG 7	6	8,5	100
MRP 11 · 7	10062162	PG 11	PG 7	6	8,5	100
MRP 11 · 9	10062163	PG 11	PG 9	6	8,5	100
MRP 13,5 · 7	10062164	PG 13,5	PG 7	6,5	9	100
MRP 13,5 · 9	10062165	PG 13,5	PG 9	6,5	9	100
MRP 13,5 · 11	10062166	PG 13,5	PG 11	6,5	9	100
MRP 16 · 7	10062167	PG 16	PG 7	6,5	9,5	100
MRP 16 · 9	10062168	PG 16	PG 9	6,5	9,5	100
MRP 16 · 11	10062169	PG 16	PG 11	6,5	9,5	100
MRP 16 · 13,5	10062170	PG 16	PG 13,5	6,5	9,5	100
MRP 21 · 11	10062171	PG 21	PG 11	7	10	50
MRP 21 · 13,5	10062172	PG 21	PG 13,5	7	10	50
MRP 21 · 16	10062173	PG 21	PG 16	7	10	50
MRP 29 · 13,5	10062174	PG 29	PG 13,5	8	11,5	50
MRP 29 · 16	10062175	PG 29	PG 16	8	11,5	50
MRP 29 · 21	10062176	PG 29	PG 21	8	11,5	50
MRP 36 · 21	10062177	PG 36	PG 21	9	12,5	25
MRP 36 · 29	10062178	PG 36	PG 29	9	12,5	25
MRP 42 · 29	10062179	PG 42	PG 29	10	14	25
MRP 42 · 36	10062180	PG 42	PG 36	10	14	25
MRP 48 · 36	10062181	PG 48	PG 36	10	14	25
MRP 48 · 42	10062182	PG 48	PG 42	10	14	25



- KABEL-VER-SCRAUBUNGEN
- KUNSTSTOFF
- METALL
- MARTIN
- EMV
- EX E/I
- EX D
- RAILWAY
- DRUCKAUSGLEICH / VENTING
- BRITISH STANDARD
- DICH-TÜNGEN
- MEMBRAN-EINFÜHRUNGEN
- MEMBRAN
- KABEL-EINFÜHRUNGSSYSTEM
- CONMAXX
- CONMAXX TEIL-VERSCRAUBUNG
- KABEL-SCHUTZ
- BRACE FITTING KUNSTSTOFF
- BRACE CONDUIT KUNSTSTOFF
- BRACE FITTING METALL
- BRACE CONDUIT METALL
- BRACE SLEEVE

HatGLAND Kabelverschraubungen, HGSM Pack, metrisch



HGSM

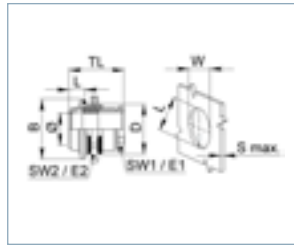

Schutzart IP68 (5 bar 30 min) / IP69
Material Verschraubung Edelstahl A2 (1.4305), Dichtung EPDM
Hinweis Inkl. Dichtung, Gegenmutter

HGSM, -40 °C bis 120 °C

Type	WISKA-No.	D (mm)	(mm)	SW 1 (mm)	SW 2 (mm)	TL (mm)	LxWxS max (mm)	BxL (mm)	
HGSM 12-E Pack	10101853	M 12x0,75	2 - 5	9	15	15,5 - 20,5	10,5x12x4mm	17x6mm	1
HGSM 16-E Pack	10101854	M 16x0,75	2 - 9	12	19	17,5 - 24,5	14,5x16x5mm	21x7mm	1
HGSM 20-E Pack	10101855	M 20x0,75	3 - 12	17	24	19,5 - 27,5	18,5x20x5,5mm	25x8mm	1
HGSM 25-E Pack	10101856	M 25x0,75	4 - 16	21	30	19,5 - 27,5	23x25x5,5mm	30x8mm	1
HGSM 32-E Pack	10101857	M 32x0,75	9 - 23	28	36	27,5 - 39,5	30x32x10mm	38x11mm	1
HGSM 40-E Pack	10101858	M 40x1,5	16 - 29	35	46	33 - 47	37x40x10mm	46x14mm	1
HGSM 50-E Pack	10101859	M 50x1,5	26 - 38	45	60	37 - 53	47x50x10mm	56x16mm	1
HGSM 63-E Pack	10101860	M 63x1,5	32 - 49	56	70	42 - 60	59x63x10mm	70x18mm	1

HGSM FD, Food, -60 °C bis 180 °C

Type	WISKA-No.	D (mm)	(mm)	SW 1 (mm)	SW 2 (mm)	TL (mm)	LxWxS max (mm)	BxL (mm)	
HGSM 12 FD Pack	10103623	M 12x0,75	2 - 5	9	15	15,5 - 20,5	10,5x12x4mm	17x6mm	1
HGSM 16 FD Pack	10103624	M 16x0,75	2 - 9	12	19	17,5 - 24,5	14,5x16x5mm	21x7mm	1
HGSM 20 FD Pack	10103625	M 20x0,75	3 - 12	17	24	19,5 - 27,5	18,5x20x5,5mm	25x8mm	1
HGSM 25 FD Pack	10103626	M 25x0,75	4 - 16	21	30	19,5 - 27,5	23x25x5,5mm	30x8mm	1
HGSM 32 FD Pack	10103627	M 32x0,75	9 - 23	28	36	27,5 - 39,5	30x32x10mm	38x11mm	1
HGSM 40 FD Pack	10103628	M 40x1,5	16 - 29	35	46	33 - 47	37x40x10mm	46x14mm	1
HGSM 50 FD Pack	10103629	M 50x1,5	26 - 38	45	60	37 - 53	47x50x10mm	56x16mm	1
HGSM 63 FD Pack	10103630	M 63x1,5	32 - 49	56	70	42 - 60	59x63x10mm	70x18mm	1

HGSM LT, LowTemp, -60 °C · 180 °C

Type	WISKA-No.	D (mm)	(mm)	SW 1 (mm)	SW 2 (mm)	TL (mm)	LxWxS max (mm)	BxL (mm)	
HGSM 12-LT Pack	10102116	M 12x0,75	2 - 5	9	15	15,5 - 20,5	10,5x12x4mm	17x6mm	1
HGSM 16-LT Pack	10102117	M 16x0,75	2 - 9	12	19	17,5 - 24,5	14,5x16x5mm	21x7mm	1
HGSM 20-LT Pack	10102118	M 20x0,75	3 - 12	17	24	19,5 - 27,5	18,5x20x5,5mm	25x8mm	1
HGSM 25-LT Pack	10102119	M 25x0,75	4 - 16	21	30	19,5 - 27,5	23x25x5,5mm	30x8mm	1
HGSM 32-LT Pack	10102120	M 32x0,75	9 - 23	28	36	27,5 - 39,5	30x32x10mm	38x11mm	1
HGSM 40-LT Pack	10102121	M 40x1,5	16 - 29	35	46	33 - 47	37x40x10mm	46x14mm	1
HGSM 50-LT Pack	10102122	M 50x1,5	26 - 38	45	60	37 - 53	47x50x10mm	56x16mm	1
HGSM 63-LT Pack	10102123	M 63x1,5	32 - 49	56	70	42 - 60	59x63x10mm	70x18mm	1

KABEL-VER-SCHRAU-BUNGEN
 KUNST-STOFF
 METALL
 MARTITIM
 ENV
 EX E/I
 EX D
 RAILWAY
 DRUCKAUS-GLEICH / VENTING
 BRITISH STANDARD
 DICH-TUNGEN
 MEMBRAN-EINFÜH-RUNGEN
 MEMBRAN
 KABEL-EINFÜH-RUNGS-SYSTEM
 CONMAXX
 CONMAXX TEILB-VER-SCHRAU-BUNG
 KABEL-SCHUTZ
 BRACE FITTING KUNST-STOFF
 BRACE CONDUIT KUNST-STOFF
 BRACE FITTING METALL
 BRACE CONDUIT METALL
 BRACE SLEEVE

SPRINT Kabelverschraubungen, ESKV, metrisch, EN 62444



ESSKV



ESSKV-4

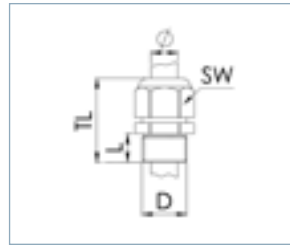

Schutzart IP68 (5 bar 30 min) / IP69
Einsatztemperatur -40 °C - 100 °C
Material Verschraubung Edelstahl, Dichtung EPDM, Klemmkäfig Polyamid

ESSKV, Edelstahl 1.4305

Type	WISKA-No.					TL (mm)	
ESSKV 12	10069000	M 12x1,5	5	3 · 7	17	23 · 30	10
ESSKV 16	10069001	M 16x1,5	5	4,5 · 10	22	26 · 34	10
ESSKV 20	10069002	M 20x1,5	6	6 · 13	24	29 · 37	10
ESSKV 25	10069003	M 25x1,5	7	9 · 17	30	33 · 42	10
ESSKV 32	10069004	M 32x1,5	8	13 · 21	36	36 · 44	5
ESSKV 40	10069005	M 40x1,5	8	16 · 28	46	44 · 55	5
ESSKV 50	10069006	M 50x1,5	9	21 · 35	55	51 · 62	2
ESSKV 63	10069007	M 63x1,5	10	34 · 48	68	56 · 67	1

ESSKV-4, Edelstahl 1.4404

Type	WISKA-No.					TL (mm)	
ESSKV-4 12	10069100	M 12x1,5	5	3 · 7	17	23 · 30	10
ESSKV-4 16	10069101	M 16x1,5	5	4,5 · 10	22	26 · 34	10
ESSKV-4 20	10069102	M 20x1,5	6	6 · 13	24	29 · 37	10
ESSKV-4 25	10069103	M 25x1,5	7	9 · 17	30	33 · 42	10
ESSKV-4 32	10069104	M 32x1,5	8	13 · 21	36	36 · 44	5
ESSKV-4 40	10069105	M 40x1,5	8	16 · 28	46	44 · 55	5
ESSKV-4 50	10069106	M 50x1,5	9	21 · 35	55	51 · 62	2
ESSKV-4 63	10069107	M 63x1,5	10	34 · 48	68	56 · 67	1

Empfohlenes Zubehör



RDE

BS

ESMU

MFD

SPRINT Kabelverschraubungen LowTemp, ESSKV LT, metrisch, EN 62444



ESSKV LT



ESSKV-4 LT

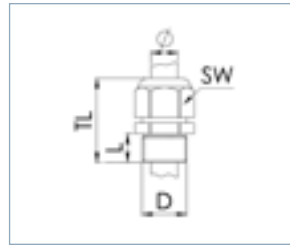

Schutzart IP68 (5 bar 30 min) / IP69
Einsatztemperatur -60 °C - 100 °C
Material Verschraubung Edelstahl, Dichtung Silikon, Klemmkäfig Polyamid

ESSKV LT, Edelstahl 1.4305

Type	WISKA-No.	D (mm)	L (mm)	Ø (mm)	SW (mm)	TL (mm)	Icon
ESSKV 12 LT	10065962	M 12x1,5	5	3 · 7	17	23 · 30	10
ESSKV 16 LT	10065963	M 16x1,5	5	4,5 · 10	22	26 · 34	10
ESSKV 20 LT	10065964	M 20x1,5	6	6 · 13	24	29 · 37	10
ESSKV 25 LT	10065965	M 25x1,5	7	9 · 17	30	33 · 42	10
ESSKV 32 LT	10065966	M 32x1,5	8	13 · 21	36	36 · 44	5
ESSKV 40 LT	10065967	M 40x1,5	8	16 · 28	46	44 · 55	5
ESSKV 50 LT	10065968	M 50x1,5	9	21 · 35	55	51 · 62	2
ESSKV 63 LT	10065969	M 63x1,5	10	34 · 48	68	56 · 67	1

ESSKV-4 LT, Edelstahl 1.4404

Type	WISKA-No.	D (mm)	L (mm)	Ø (mm)	SW (mm)	TL (mm)	Icon
ESSKV-4 12 LT	10065881	M 12x1,5	5	3 · 7	17	23 · 30	10
ESSKV-4 16 LT	10065882	M 16x1,5	5	4,5 · 10	22	26 · 34	10
ESSKV-4 20 LT	10065883	M 20x1,5	6	6 · 13	24	29 · 37	10
ESSKV-4 25 LT	10065884	M 25x1,5	7	9 · 17	30	33 · 42	10
ESSKV-4 32 LT	10065885	M 32x1,5	8	13 · 21	36	36 · 44	5
ESSKV-4 40 LT	10065886	M 40x1,5	8	16 · 28	46	44 · 55	5
ESSKV-4 50 LT	10065887	M 50x1,5	9	21 · 35	55	51 · 62	2
ESSKV-4 63 LT	10065888	M 63x1,5	10	34 · 48	68	56 · 67	1

Empfohlenes Zubehör

RDE LT BS ESMU

KABEL-VER-SCHRAU-BUNGEN
 KUNST-STOFF
 METALL
 MARTIM
 ENV
 EX E/I
 EX D
 RAILWAY
 DRUCKAUS-GLEICH / VENTING
 BRITISH STANDARD
 DICH-TUNGEN
 MEMBRAN-EINFÜH-RUNGEN
 MEMBRAN
 KABEL-EINFÜH-RUNGS-SYSTEM
 CONMAXX
 CONMAXX TEILB. VER-SCHRAU-BUNG
 KABEL-SCHUTZ
 BRACE FITTING KUNST-STOFF
 BRACE CONDUIT KUNST-STOFF
 BRACE FITTING METALL
 BRACE CONDUIT METALL
 BRACE SLEEVE

Gegenmuttern, ESMU, metrisch

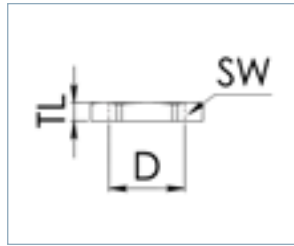

ESMU



Material Edelstahl 1.4305

Type	WISKA-No.	D (mm)	SW (mm)	TL (mm)	
ESMU 12	10064188	M 12x1,5	15	2,8	10
ESMU 16	10064189	M 16x1,5	19	2,8	10
ESMU 20	10064190	M 20x1,5	24	3	10
ESMU 25	10064191	M 25x1,5	30	3,5	10
ESMU 32	10064192	M 32x1,5	36	4	5
ESMU 40	10064193	M 40x1,5	46	5	5
ESMU 50	10064194	M 50x1,5	60	5	2
ESMU 63	10064195	M 63x1,5	70	6	1

- KABEL-VER-SCHRAUBUNGEN
- KUNSTSTOFF
- METALL
- MARTIN
- EMV
- EX E/ I
- EX D
- RAILWAY
- DRUCKAUSGLEICH / VENTING
- BRITISH STANDARD
- DICH-TÜNGEN
- MEMBRAN-EINFÜHRUNGEN
- MEMBRAN
- KABEL-EINFÜHRUNGSSYSTEM
- CONMAXX
- CONMAXX TEIL-VER-SCHRAUBUNG
- KABEL-SCHUTZ
- BRACE FITTING KUNSTSTOFF
- BRACE CONDUIT KUNSTSTOFF
- BRACE FITTING METALL
- BRACE CONDUIT METALL
- BRACE SLEEVE

Verschlusschrauben, ESVS, metrisch



ESVS

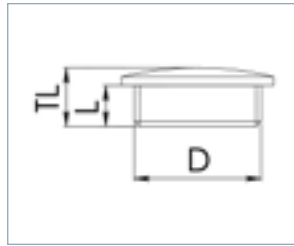

Schutzart IP54
Material Edelstahl 1.4305
Hinweis mit O-Ring IP66 / IP68

Type	WISKA-No.			TL (mm)	
ESVS 12	10065460	M 12x1,5	5	7,5	10
ESVS 16	10065461	M 16x1,5	5	8	10
ESVS 20	10065462	M 20x1,5	6,5	9,5	10
ESVS 25	10065463	M 25x1,5	7	11	10
ESVS 32	10065464	M 32x1,5	8	12	5
ESVS 40	10065465	M 40x1,5	8,5	13	5
ESVS 50	10065466	M 50x1,5	9	15	2
ESVS 63	10065467	M 63x1,5	10	16	1

Empfohlenes Zubehör



ESMU

ORD-E

- KABEL-VER-SCHRAU-BUNGEN
- KUNST-STOFF
- METALL
- MARTITIM
- EMV
- EX E/I
- EX D
- RAILWAY
- BRÜCKEN-DRUCKHAUS-GLEICH / VENTING
- BRITISH STANDARD
- DICH-TUNGEN
- MEMBRAN-EINFÜH-RUNGEN
- MEMBRAN
- KABEL-EINFÜH-RUNGS-SYSTEM
- CONMAXX
- CONMAXX TEILB. VER-SCHRAU-BUNG
- KABEL-SCHUTZ
- BRACE FITTING KUNST-STOFF
- BRACE CONDUIT KUNST-STOFF
- BRACE FITTING METALL
- BRACE CONDUIT METALL
- BRACE SLEEVE

MARATHON Kabelverschraubungen, EZMGV-L, metrisch

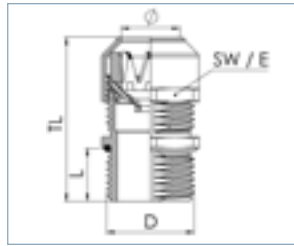

EZMGV-L



Schutzart IP 66 / 68
Einsatztemperatur -40 °C - 80 °C
Material Verschraubung Zink, Dichtung EPDM, Klemmkäfig Polyamid / TPE
Hinweis Zugentlastung Kategorie B (EN62444), bei 8 bis 13 mm

Type	WISKA-No.					TL (mm)	
EZMGV-L 20	10108742	M 20x1,5	12	6 - 13	22	29 - 37	50

- KABEL-VER-SCHRAUBUNGEN
- KUNST-STOFF
- METALL
- MARITIM
- EMV
- EX E/I
- EX D
- RAILWAY
- DRUCKAUSGLEICH / VENTING
- BRITISH STANDARD
- DICH-TUNGEN
- MEMBRAN-EINFÜHRUNGEN
- MEMBRAN
- KABEL-EINFÜHRUNGS-SYSTEM
- CONNMAXX
- CONNMAXX TEIL-VER-SCHRAUBUNGEN
- KABEL-SCHUTZ
- BRACE FITTING KUNST-STOFF
- BRACE CONDUIT KUNST-STOFF
- BRACE FITTING METALL
- BRACE CONDUIT METALL
- BRACE SLEEVE



Maritime Kabelverschraubungen

Wenn Sie Kabelverschraubungen für die maritime Industrie on- oder offshore suchen, bieten wir Ihnen Messing-Kabelverschraubungen und Zubehör gemäß DIN 89280 und DIN 89285. Diese sind optimiert für den Einsatz unter rauen Bedingungen auf Schiffen und Offshore-Anlagen.

SPRINT Kabelverschraubungen, MMSKV, metrisch, DIN 89285



MMSKV



MMSKV EMV-Z

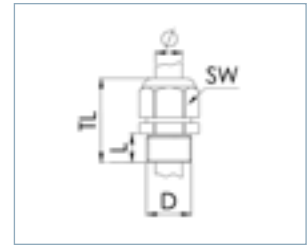

Schutzart IP68 (5 bar 30 min) / IP69
Einsatztemperatur -40 °C - 100 °C
Material Verschraubung Messing, Klemmkäfig Polyamid, Dichtung EPDM

MMSKV

Type	WISKA-No. blank	WISKA-No. Ni	WISKA-No. Cr					TL (mm)	
MMSKV 16	10065101	10065108	10065115	M 16x1,5	9	4,5 - 10	20	30 - 38	1
MMSKV 18	10065102	10065109	10065116	M 18x1,5	10	6 - 13	24	33 - 41	1
MMSKV 24	10065103	10065110	10065117	M 24x1,5	11	9 - 17	29	37 - 46	1
MMSKV 30	10065104	10065111	10065118	M 30x2	12	13 - 21	36	40 - 48	1
MMSKV 36	10065105	10065112	10065119	M 36x2	13	16 - 28	46	49 - 60	1
MMSKV 45	10065106	10065113	10065120	M 45x2	14	21 - 35	55	56 - 67	1
MMSKV 56	10065107	10065114	10065121	M 56x2	15	34 - 48	68	61 - 72	1

MMSKV EMV-Z

Type	WISKA-No. blank	WISKA-No. Ni	WISKA-No. Cr					TL (mm)	
MMSKV 16 EMV-Z	10065122	10065129	10065136	M 16x1,5	9	4,5 - 10	20	30 - 38	1
MMSKV 18 EMV-Z	10065123	10065130	10065137	M 18x1,5	10	6 - 13	24	33 - 41	1
MMSKV 24 EMV-Z	10065124	10065131	10065138	M 24x1,5	11	9 - 17	29	37 - 46	1
MMSKV 30 EMV-Z	10065125	10065132	10065139	M 30x2	12	13 - 21	36	40 - 48	1
MMSKV 36 EMV-Z	10065126	10065133	10065140	M 36x2	13	16 - 28	46	49 - 60	1
MMSKV 45 EMV-Z	10065127	10065134	10065141	M 45x2	14	21 - 35	55	56 - 67	1
MMSKV 56 EMV-Z	10065128	10065135	10065142	M 56x2	15	34 - 48	68	61 - 72	1

Empfohlenes Zubehör



RDE

MFD

GM

Kabelverschraubungen rund, KVM, metrisch, DIN 89280



KVM



W-Einsatz



Z-Einsatz

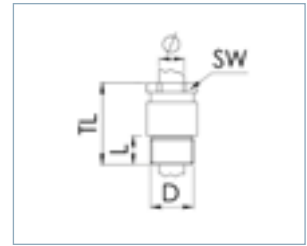





Schutzart IP54
Einsatztemperatur -40 °C - 100 °C
Material Verschraubung Messing, Dichtung EPDM
Hinweis *Ähnlich DIN 89280

KVM, Typ Z

Type	WISKA-No. blank	WISKA-No. Ni	WISKA-No. Cr					TL (mm)	
KVM 18-Z8	10010833	10013118	10014478	M 18x1,5	10	7 - 8,5	19	43	1
KVM 18-Z10	10010835	10010384	10014481	M 18x1,5	10	8 - 10,5	19	43	1
KVM 24-Z8A	10010836	10014480	10014482	M 24x1,5	11	7 - 8,5	24	49	1
KVM 24-Z10A	10010837	10014484	10014157	M 24x1,5	11	8 - 10,5	24	49	1
KVM 24-Z12	10010839	10012807	10014486	M 24x1,5	11	10 - 12,5	24	49	1
KVM 24-Z14	10010840	10012812	10014392	M 24x1,5	11	12 - 14,5	24	49	1
KVM 24-Z16	10010841	10014488	10014487	M 24x1,5	11	14 - 16,5	24	49	1
KVM 24-Z17	10010842	10014490	10014489	M 24x1,5	11	16 - 17,5	24	49	1
KVM 30-Z18	10010843	10013310	10014183	M 30x2	12	16 - 18,5	30	52	1
KVM 30-Z20	10010844	10013420	10014341	M 30x2	12	18 - 20,5	30	52	1
KVM 36-Z22	10010846	10013311	10014493	M 36x2	13	20 - 22,5	36	58	1
KVM 36-Z24	10010847	10014494	10014184	M 36x2	13	22 - 24,5	36	58	1
KVM 36-Z26	10010848	10014496	10014495	M 36x2	13	24 - 26,5	36	58	1
KVM 45-Z28	10010849	10014498	10014497	M 45x2	14	26 - 28,5	46	62	1
KVM 45-Z30	10010850	10014499	10014342	M 45x2	14	28 - 30,5	46	62	1
KVM 45-Z32	10010851	10013322	10014500	M 45x2	14	30 - 32,5	46	62	1
KVM 56-Z35	10010852	10014542	10014541	M 56x2	15	32 - 35,5	55	68	1
KVM 56-Z38	10010853	10013301	10014540	M 56x2	15	35 - 38,5	55	68	1
KVM 56-Z41	10010854	10013323	10014543	M 56x2	15	38 - 41,5	55	68	1
KVM 72-Z44	10010855	10014550	10014544	M 72x2	16	41 - 44,5	70	73	1
KVM 72-Z48	10010856	10013302	10014545	M 72x2	16	44 - 48,5	70	73	1
KVM 72-Z52	10010857	10014551	10014546	M 72x2	16	48 - 52,5	70	73	1
KVM 80-Z61*	10016543	10101672	10016581	M 80x2	18	59 - 62	85	79	1
KVM 80-Z64*	10010858	10014552	10014547	M 80x2	18	62 - 66	85	79	1
KVM 105-Z70*	10010859	10014553	10014548	M 105x2	20	68 - 73	105	88	1
KVM 105-Z75*	10010860	10014554	10014549	M 105x2	20	73 - 78	105	88	1

KABEL-VER-SCHRAUBUNGEN
 KUNST-STOFF
 METALL
 MARITIM
 ENV
 EX E/I
 EX D
 RAILWAY
 DRUCKAUS-GLEICH / VENTING
 BRITISH STANDARD
 DICH-TUNGEN
 MEMBRAN-EINFÜHRUNGEN
 MEMBRAN
 KABEL-EINFÜHRUNGS-SYSTEM
 CONMAXX
 CONMAXX TEILB. VER-SCHRAUBUNG
 KABEL-SCHUTZ
 BRACE FITTING KUNST-STOFF
 BRACE CONDUIT KUNST-STOFF
 BRACE FITTING METALL
 BRACE CONDUIT METALL
 BRACE SLEEVE

KVM, Typ W

Type	WISKA-No. blank	WISKA-No. Ni	WISKA-No. Cr					TL (mm)	
KVM 18-W8	10010862	10014561	10014562	M 18x1,5	10	7 - 8,5	19	43	1
KVM 18-W10	10010863	10014563	10014564	M 18x1,5	10	8 - 10,5	19	43	1
KVM 24-W8A	10010864	10014565	10014566	M 24x1,5	11	7 - 8,5	24	49	1
KVM 24-W10A	10010865	10013483	10014567	M 24x1,5	11	8 - 10,5	24	49	1
KVM 24-W12	10010866	10014212	10014568	M 24x1,5	11	10 - 12,5	24	49	1
KVM 24-W14	10010867	10012933	10014569	M 24x1,5	11	12 - 14,5	24	49	1
KVM 24-W16	10010868	10014570	10014571	M 24x1,5	11	14 - 16,5	24	49	1
KVM 24-W17	10010869	10014572	10014573	M 24x1,5	11	16 - 17,5	24	49	1
KVM 30-W18	10010871	10014576	10014577	M 30x2	12	16 - 18,5	30	52	1
KVM 30-W20	10010872	10014578	10014470	M 30x2	12	18 - 20,5	30	52	1
KVM 36-W22	10010875	10014582	10014583	M 36x2	13	20 - 22,5	36	58	1
KVM 36-W24	10010876	10014584	10014585	M 36x2	13	22 - 24,5	36	58	1
KVM 36-W26	10010877	10013069	10014586	M 36x2	13	24 - 26,5	36	58	1
KVM 45-W28	10010878	10012299	10014587	M 45x2	14	26 - 28,5	46	62	1
KVM 45-W30	10010879	10014588	10014589	M 45x2	14	28 - 30,5	46	62	1
KVM 45-W32	10010880	10014590	10014591	M 45x2	14	30 - 32,5	46	62	1
KVM 56-W35	10010881	10014592	10014593	M 56x2	15	32 - 35,5	55	68	1
KVM 56-W38	10010882	10014594	10014595	M 56x2	15	35 - 38,5	55	68	1
KVM 56-W41	10010883	10014596	10014597	M 56x2	15	38 - 41,5	55	68	1
KVM 72-W44	10010884	10014598	10014599	M 72x2	16	41 - 44,5	70	73	1
KVM 72-W48	10010885	10014600	10014601	M 72x2	16	44 - 48,5	70	73	1
KVM 72-W52	10010886	10014602	10014603	M 72x2	16	48 - 52,5	70	73	1
KVM 72-W56	10010887	10014311	10014604	M 72x2	16	52 - 56,5	70	73	1
KVM 80-W61*	10016453	10016454	10016455	M 80x2	18	59 - 62	85	79	1
KVM 80-W64*	10010888	10014605	10014606	M 80x2	18	62 - 66	85	79	1
KVM 105-W70*	10010890	10014607	10014608	M 105x2	20	68 - 73	105	88	1
KVM 105-W75	10010891			M 105x2	20	73 - 78	105	88	1
KVM 105-W80*	10010892	10016208	10014612	M 105x2	20	78 - 83	105	88	1
KVM 105-W75*		10016207	10014610	M 105x2	20	73 - 78	105	88	1

Empfohlenes Zubehör



GM

Gegenmutter, GM, metrisch, DIN 89280

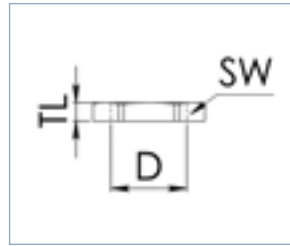



GM



Material
Hinweis

Messing
*Ähnlich DIN 89280

Type	WISKA-No. blank	WISKA-No. Ni	WISKA-No. Cr	 D (mm)	 SW (mm)	TL (mm)	
GM 16	50013662	10011606	10014237	M 16x1,5	22	4	1
GM 18	50011419	10012963	10011533	M 18x1,5	22	4	1
GM 24	50011420	10013175	10011532	M 24x1,5	30	5	1
GM 30	50011421	10012814	10011531	M 30x2	36	6	1
GM 36	50011422	10012815	10011530	M 36x2	41	7	1
GM 45	50011423	10011559	10011529	M 45x2	55	8	1
GM 56	50011424	10011557	10011528	M 56x2	65	9	1
GM 72	50011425	30070555	10012075	M 72x2	85	10	1
GM 80*	50011426	10014199	10011858	M 80x2	90	11	1
GM 105*	50011427	10011708	10103708	M 105x2	120	14	1

- KABEL-VER-SCHRAU-BUNGEN
- KUNST-STOFF
- METALL
- MARITIM
- ENV
- EX E/I
- EX D
- RAILWAY
- BRÜCKAUS-GLEICH / VENTING
- BRITISH STANDARD
- DICH-TUNGEN
- MEMBRAN-EINFÜH-RUNGEN
- MEMBRAN
- KABEL-EINFÜH-RUNGS-SYSTEM
- CONMAXX
- CONMAXX TEILB. VER-SCHRAU-BUNG
- KABEL-SCHUTZ
- BRACE FITTING KUNST-STOFF
- BRACE CONDUIT KUNST-STOFF
- BRACE FITTING METALL
- BRACE CONDUIT METALL
- BRACE SLEEVE

Verschlusschrauben, VSM, metrisch, DIN 89284

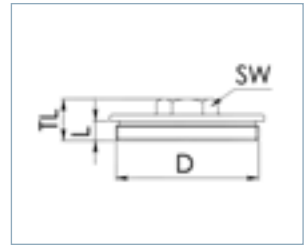
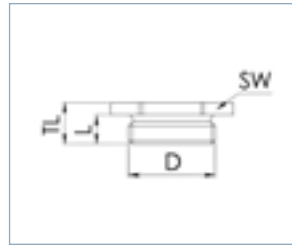

VSM



Material Hinweis

Messing
*Ähnlich DIN 89280

Type	WISKA-No. blank	WISKA-No. Ni	WISKA-No. Cr				TL (mm)	Form	
VSM 16	50084870	50016772	50016782	M 16x1,5	8	22	11,5	A	1
VSM 18	50084875	10012980	10016783	M 18x1,5	8	22	11,5	A	1
VSM 20*	50084871	10016685	10016684	M 20x1,5	8	24	11,5	A	1
VSM 24	50084876	50016774	10016784	M 24x1,5	9	30	13	A	1
VSM 25*	50084872	50016687	50016686	M 25x1,5	9	30	13	A	1
VSM 30	50084877	50016775	50016785	M 30x2	10	36	14	A	1
VSM 32*	50084873	10016689	50016688	M 32x1,5	10	36	14	A	1
VSM 36	50084874	10016776	50016786	M 36x2	12	41	17	A	1
VSM 40*	50084670	10016691	10016690	M 40x1,5	12	22	22	B	1
VSM 45	50084671	10016777	10016787	M 45x2	12	22	22	B	1
VSM 50*	50084672	10016693	10016692	M 50x1,5	12	27	22	B	1
VSM 56	50084673	10016778	10016788	M 56x2	12	27	22	B	1
VSM 63*	50084674	10016695	10016694	M 63x1,5	12	27	22	B	1
VSM 72	50084675	10016779	10016789	M 72x2	12	27	22	B	1
VSM 75*	50084676	10016697	10016696	M 75x2	12	27	22	B	1
VSM 80*	50084677	10016780	10016790	M 80x2	12	27	22	B	1
VSM 105*	50084678	10016781	10016791	M 105x2	12	27	22	B	1



EMV-Kabelverschraubungen

Mit immer leistungsfähigeren und komplexeren Technologien erhöht sich auch die Anfälligkeit von Elektroteilen für elektromagnetische Störungen. Zum Schutz vor Wechselwirkungen bieten wir Ihnen zwei verschiedene Ansätze für EMV-Kabelverschraubungen, die jeweils ein wirksames 360° Schirmungskonzept sowie eine dauerhafte Dichtigkeit mit IP68 / 69 gewährleisten.

SPRINT EMV Kabelverschraubungen mit Kontaktfedereinsatz, EMSKV EMV-S, Messing vernickelt, metrisch, EN 62444

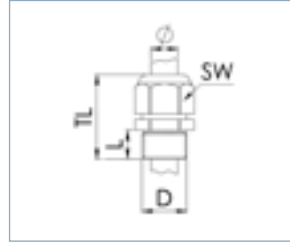







EMSKV EMV-S









Schutzart IP68 (5 bar 30 min) / IP69
Einsatztemperatur -40 °C - 100 °C
Material Verschraubung Messing vernickelt, Klemmkäfig Polyamid, Dichtung EPDM, Kontaktfedereinsatz Edelstahl 1.4310

EMSKV EMV-S

Type	WISKA-No. Ni	 D (mm)	 L (mm)	 (mm)	 (mm)	 SW (mm)	TL (mm)	
EMSKV 12 EMV-S	10102273	M 12x1,5	5	3 - 7	2 - 6	16	23 - 30	50
EMSKV 16 EMV-S	10102274	M 16x1,5	5	4,5 - 10	3 - 9	20	26 - 34	50
EMSKV 20 EMV-S	10102275	M 20x1,5	6	6 - 13	5 - 12	24	29 - 37	50
EMSKV 25 EMV-S	10102276	M 25x1,5	7	9 - 17	7,5 - 13,5	29	33 - 42	50
EMSKV 32 EMV-S	10102277	M 32x1,5	8	13 - 21	11 - 19	36	36 - 44	25
EMSKV 40 EMV-S	10102278	M 40x1,5	8	16 - 28	14 - 26	46	44 - 55	10
EMSKV 50 EMV-S	10102279	M 50x1,5	9	21 - 35	18 - 32	55	51 - 62	10
EMSKV 63 EMV-S	10102280	M 63x1,5	10	34 - 48	30 - 44	68	56 - 67	10

EMSKV-L EMV-S, lang

Type	WISKA-No. Ni	 D (mm)	 L (mm)	 (mm)	 (mm)	 SW (mm)	TL (mm)	
EMSKV-L 12 EMV-S	10102645	M 12x1,5	12	3 - 7	5	16	30 - 37	50
EMSKV-L 16 EMV-S	10102646	M 16x1,5	12	4,5 - 10	7,5	20	33 - 41	50
EMSKV-L 20 EMV-S	10102647	M 20x1,5	12	6 - 13	9,5	24	35 - 43	50
EMSKV-L 25 EMV-S	10102648	M 25x1,5	12	9 - 17	16	29	38 - 47	50
EMSKV-L 32 EMV-S	10102649	M 32x1,5	15	13 - 21	20	36	43 - 51	25
EMSKV-L 40 EMV-S	10102650	M 40x1,5	15	16 - 28	26	46	51 - 62	10
EMSKV-L 50 EMV-S	10102651	M 50x1,5	15	21 - 35	33	55	57 - 68	10
EMSKV-L 63 EMV-S	10102652	M 63x1,5	15	34 - 48	45	68	61 - 72	10

Empfohlenes Zubehör



RDE

EMMU-EMV

BS

SPRINT EMV Kabelverschraubungen mit Erdungseinsatz DIN 89345, EMSKV EMV-Z, Messing vernickelt, metrisch, EN 62444



EMSKV EMV-Z

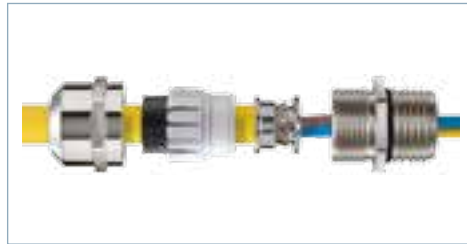

EMSKV-L EMV-Z

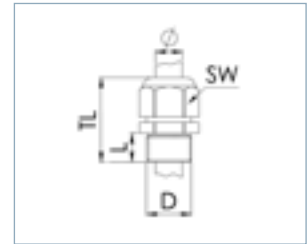

Schutzart IP68 (5 bar 30 min) / IP69
Einsatztemperatur -40 °C - 100 °C
Material Verschraubung Messing vernickelt, Klemmkäfig Polyamid, Dichtung EPDM, Erdungseinsatz Messing verchromt

EMSKV EMV-Z

Type	WISKA-No. Ni	D (mm)	L (mm)	Ø (mm)	Ø (mm)	SW (mm)	TL (mm)	
EMSKV 12 EMV-Z	10065016	M 12x1,5	5	3 - 7	5	16	23 - 30	50
EMSKV 16 EMV-Z	10065017	M 16x1,5	5	4,5 - 10	7,5	20	26 - 34	50
EMSKV 20 EMV-Z	10065018	M 20x1,5	6	6 - 13	9,5	24	29 - 37	50
EMSKV 25 EMV-Z	10065019	M 25x1,5	7	9 - 17	16	29	33 - 42	50
EMSKV 32 EMV-Z	10065020	M 32x1,5	8	13 - 21	20	36	36 - 44	25
EMSKV 40 EMV-Z	10065021	M 40x1,5	8	16 - 28	26	46	44 - 55	10
EMSKV 50 EMV-Z	10065022	M 50x1,5	9	21 - 35	33	55	51 - 62	10
EMSKV 63 EMV-Z	10065023	M 63x1,5	10	34 - 48	45	68	56 - 67	10
EMSKV 75 EMV-Z	10100963	M 75x1,5	12	48 - 63	58	82	67 - 81	1

EMSKV-L EMV-Z, lang

Type	WISKA-No. Ni	D (mm)	L (mm)	Ø (mm)	Ø (mm)	SW (mm)	TL (mm)	
EMSKV-L 12 EMV-Z	10065182	M 12x1,5	12	3 - 7	5	16	30 - 37	50
EMSKV-L 16 EMV-Z	10065183	M 16x1,5	12	4,5 - 10	7,5	20	33 - 41	50
EMSKV-L 20 EMV-Z	10065184	M 20x1,5	12	6 - 13	9,5	24	35 - 43	50
EMSKV-L 25 EMV-Z	10065185	M 25x1,5	12	9 - 17	16	29	38 - 47	50
EMSKV-L 32 EMV-Z	10065186	M 32x1,5	15	13 - 21	20	36	43 - 51	25
EMSKV-L 40 EMV-Z	10065187	M 40x1,5	15	16 - 28	26	46	51 - 62	10
EMSKV-L 50 EMV-Z	10065188	M 50x1,5	15	21 - 35	33	55	57 - 68	10
EMSKV-L 63 EMV-Z	10065189	M 63x1,5	15	34 - 48	45	68	61 - 72	10

Empfohlenes Zubehör



RDE

EMMU-EMV

BS

KABEL-VER-SCHRAUBUNGEN
 KUNST-STOFF
 METALL
 MARTIM
 EMV
 EX E/I
 EX D
 RAILWAY
 DRUCKAUS-GLEICH / VENTING
 BRITISH STANDARD
 DICH-TUNGEN
 MEMBRAN-EINFÜHRUNGEN
 MEMBRAN
 KABEL-EINFÜHRUNGS-SYSTEM
 CONMAXX
 CONMAXX TEILB. VER-SCHRAUBUNG
 KABEL-SCHUTZ
 BRACE FITTING KUNST-STOFF
 BRACE CONDUIT KUNST-STOFF
 BRACE FITTING METALL
 BRACE CONDUIT METALL
 BRACE SLEEVE

ShotGLAND EMV Kompressionsverschraubungen mit Erdungseinsatz DIN 89345, Messing, EMCGV EMV-Z, metrisch, EN 62444





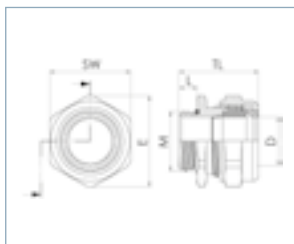

EMCGV EMV-Z



Schutzart IP68 (5 bar 30 min)
Einsatztemperatur -40 °C · 120 °C
Material Verschraubung Messing vernickelt, Dichtung EPDM, Erdungseinsatz Messing verchromt

Type	WISKA-No. Ni	D (mm)	L (mm)	(mm)	SW (mm)	TL (mm)	
EMCGV 8-030 EMV-Z	10106442	M 8x1,25	5	2 · 3,3	11	15 · 18,5	50
EMCGV 8-040 EMV-Z	10106443	M 8x1,25	5	3 · 4,3	11	15 · 18,5	50
EMCGV 8-050 EMV-Z	10106445	M 8x1,25	5	4 · 5,3	11	15 · 18,5	50
EMCGV 12-030 EMV-Z	10106446	M 12x1,5	6	2 · 3	18	20,5 · 24,5	50
EMCGV 12-050 EMV-Z	10106447	M 12x1,5	6	3 · 5	18	20,5 · 24,5	50
EMCGV 12-070 EMV-Z	10106448	M 12x1,5	6	5 · 7	18	20,5 · 24,5	50
EMCGV 12-090 EMV-Z	10106449	M 12x1,5	6	7 · 9	18	20,5 · 24,5	50
EMCGV 16-040 EMV-Z	10106450	M 16x1,5	6	2 · 4	22	22 · 26,5	50
EMCGV 16-060 EMV-Z	10106451	M 16x1,5	6	4 · 6	22	22 · 26,5	50
EMCGV 16-080 EMV-Z	10106452	M 16x1,5	6	6 · 8	22	22 · 26,5	50
EMCGV 16-100 EMV-Z	10106453	M 16x1,5	6	8 · 10	22	22 · 26,5	50
EMCGV 16-120 EMV-Z	10106454	M 16x1,5	6	10 · 12	22	22 · 26,5	50
EMCGV 20-060 EMV-Z	10106455	M 20x1,5	6	4 · 6	27	22 · 26,5	50
EMCGV 20-080 EMV-Z	10106456	M 20x1,5	6	6 · 8	27	22 · 26,5	50
EMCGV 20-100 EMV-Z	10106457	M 20x1,5	6	8 · 10	27	22 · 26,5	50
EMCGV 20-120 EMV-Z	10106458	M 20x1,5	6	10 · 12	27	22 · 26,5	50
EMCGV 20-140 EMV-Z	10106459	M 20x1,5	6	12 · 14	27	22 · 26,5	50
EMCGV 20-160 EMV-Z	10106460	M 20x1,5	6	14 · 16	27	22 · 26,5	50
EMCGV 25-080 EMV-Z	10106461	M 25x1,5	7	6 · 8	30	23 · 28	50
EMCGV 25-100 EMV-Z	10106462	M 25x1,5	7	8 · 10	30	23 · 28	50
EMCGV 25-120 EMV-Z	10106463	M 25x1,5	7	10 · 12	30	23 · 28	50
EMCGV 25-140 EMV-Z	10106464	M 25x1,5	7	12 · 14	30	23 · 28	50
EMCGV 25-160 EMV-Z	10106465	M 25x1,5	7	14 · 16	30	23 · 28	50
EMCGV 25-170 EMV-Z	10106466	M 25x1,5	7	15 · 17	30	23 · 28	50
EMCGV 32-110 EMV-Z	10106467	M 32x1,5	8	9 · 11	36	24 · 28,5	25
EMCGV 32-130 EMV-Z	10106468	M 32x1,5	8	11 · 13	36	24 · 28,5	25
EMCGV 32-150 EMV-Z	10106469	M 32x1,5	8	13 · 15	36	24 · 28,5	25
EMCGV 32-180 EMV-Z	10106470	M 32x1,5	8	16 · 18	36	24 · 28,5	25
EMCGV 32-200 EMV-Z	10106471	M 32x1,5	8	18 · 20	36	24 · 28,5	25
EMCGV 32-230 EMV-Z	10106473	M 32x1,5	8	21 · 23	36	24 · 28,5	25
EMCGV 40-180 EMV-Z	10106474	M 40x1,5	8	16 · 18	45	24 · 28,5	10
EMCGV 40-200 EMV-Z	10106475	M 40x1,5	8	18 · 20	45	24 · 28,5	10
EMCGV 40-220 EMV-Z	10106476	M 40x1,5	8	20 · 22	45	24 · 28,5	10
EMCGV 40-240 EMV-Z	10106477	M 40x1,5	8	22 · 24	45	24 · 28,5	10
EMCGV 40-260 EMV-Z	10106478	M 40x1,5	8	24 · 26	45	24 · 28,5	10
EMCGV 40-290 EMV-Z	10106479	M 40x1,5	8	26 · 29	45	24 · 28,5	10
EMCGV 50-280 EMV-Z	10106480	M 50x1,5	9	26 · 28	55	25,5 · 30	10
EMCGV 50-300 EMV-Z	10106481	M 50x1,5	9	28 · 30	55	25,5 · 30	10
EMCGV 50-320 EMV-Z	10106482	M 50x1,5	9	30 · 32	55	25,5 · 30	10
EMCGV 50-340 EMV-Z	10106483	M 50x1,5	9	32 · 34	55	25,5 · 30	10
EMCGV 50-360 EMV-Z	10106484	M 50x1,5	9	34 · 36	55	25,5 · 30	10
EMCGV 50-380 EMV-Z	10106485	M 50x1,5	9	36 · 38	55	25,5 · 30	10

Type	WISKA-No. Ni	 D (mm)	 L (mm)	 (mm)	 SW (mm)	TL (mm)	
EMCGV 63-350 EMV-Z	10106486	M 63x1,5	10	33 · 35	68	26,5 · 31	10
EMCGV 63-380 EMV-Z	10106487	M 63x1,5	10	35 · 38	68	26,5 · 31	10
EMCGV 63-410 EMV-Z	10106488	M 63x1,5	10	38 · 41	68	26,5 · 31	10
EMCGV 63-440 EMV-Z	10106489	M 63x1,5	10	41 · 44	68	26,5 · 31	10
EMCGV 63-470 EMV-Z	10106490	M 63x1,5	10	44 · 47	68	26,5 · 31	10
EMCGV 63-490 EMV-Z	10106491	M 63x1,5	10	47 · 49	68	26,5 · 31	10

ShotGLAND EMV Kompressionsverschraubungen LowTemp mit Erdungseinsatz DIN 89345, EMCGV LT EMV-Z, Messing, metrisch, EN 62444



EMCGV LT EMV-Z

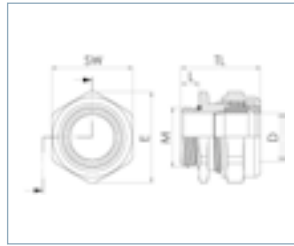





Schutzart
Einsatztemperatur
Material





IP68 (5 bar 30 min)

-60 °C · 180 °C

Verschraubung Messing vernickelt, Dichtung Silikon, Erdungseinsatz Messing verchromt

Type	WISKA-No. Ni	 D (mm)	 L (mm)	 (mm)	 SW (mm)	TL (mm)	
EMCGV 8-030 LT EMV-Z	10106540	M 8x1,25	5	2 · 3,3	11	15 · 18,5	50
EMCGV 8-040 LT EMV-Z	10106541	M 8x1,25	5	3 · 4,3	11	15 · 18,5	50
EMCGV 8-050 LT EMV-Z	10106542	M 8x1,25	5	4 · 5,3	11	15 · 18,5	50
EMCGV 12-030 LT EMV-Z	10106543	M 12x1,5	6	2 · 3	18	20,5 · 24,5	50
EMCGV 12-050 LT EMV-Z	10106544	M 12x1,5	6	3 · 5	18	20,5 · 24,5	50
EMCGV 12-070 LT EMV-Z	10106545	M 12x1,5	6	5 · 7	18	20,5 · 24,5	50
EMCGV 12-090 LT EMV-Z	10106546	M 12x1,5	6	7 · 9	18	20,5 · 24,5	50
EMCGV 16-040 LT EMV-Z	10106547	M 16x1,5	6	2 · 4	22	22 · 26,5	50
EMCGV 16-060 LT EMV-Z	10106548	M 16x1,5	6	4 · 6	22	22 · 26,5	50
EMCGV 16-080 LT EMV-Z	10106549	M 16x1,5	6	6 · 8	22	22 · 26,5	50
EMCGV 16-100 LT EMV-Z	10106550	M 16x1,5	6	8 · 10	22	22 · 26,5	50
EMCGV 16-120 LT EMV-Z	10106551	M 16x1,5	6	10 · 12	22	22 · 26,5	50
EMCGV 20-060 LT EMV-Z	10106552	M 20x1,5	6	4 · 6	27	22 · 26,5	50
EMCGV 20-080 LT EMV-Z	10106553	M 20x1,5	6	6 · 8	27	22 · 26,5	50
EMCGV 20-100 LT EMV-Z	10106554	M 20x1,5	6	8 · 10	27	22 · 26,5	50
EMCGV 20-120 LT EMV-Z	10106555	M 20x1,5	6	10 · 12	27	22 · 26,5	50
EMCGV 20-140 LT EMV-Z	10106556	M 20x1,5	6	12 · 14	27	22 · 26,5	50
EMCGV 20-160 LT EMV-Z	10106557	M 20x1,5	6	14 · 16	27	22 · 26,5	50
EMCGV 25-080 LT EMV-Z	10106558	M 25x1,5	7	6 · 8	30	23 · 28	50
EMCGV 25-100 LT EMV-Z	10106559	M 25x1,5	7	8 · 10	30	23 · 28	50
EMCGV 25-120 LT EMV-Z	10106560	M 25x1,5	7	10 · 12	30	23 · 28	50
EMCGV 25-140 LT EMV-Z	10106561	M 25x1,5	7	12 · 14	30	23 · 28	50
EMCGV 25-160 LT EMV-Z	10106562	M 25x1,5	7	14 · 16	30	23 · 28	50
EMCGV 25-170 LT EMV-Z	10106563	M 25x1,5	7	15 · 17	30	23 · 28	50
EMCGV 32-110 LT EMV-Z	10106564	M 32x1,5	8	9 · 11	36	24 · 28,5	25
EMCGV 32-130 LT EMV-Z	10106565	M 32x1,5	8	11 · 13	36	24 · 28,5	25
EMCGV 32-150 LT EMV-Z	10106566	M 32x1,5	8	13 · 15	36	24 · 28,5	25
EMCGV 32-180 LT EMV-Z	10106567	M 32x1,5	8	16 · 18	36	24 · 28,5	25
EMCGV 32-200 LT EMV-Z	10106568	M 32x1,5	8	18 · 20	36	24 · 28,5	25
EMCGV 32-230 LT EMV-Z	10106570	M 32x1,5	8	21 · 23	36	24 · 28,5	25

EMV-Kabelverschraubungen

Type	WISKA-No. NI	 D (mm)	 L (mm)	 L (mm)	 SW (mm)	TL (mm)	
EMCGV 40-180 LT EMV-Z	10106571	M 40x1,5	8	16 · 18	45	24 · 28,5	10
EMCGV 40-200 LT EMV-Z	10106572	M 40x1,5	8	18 · 20	45	24 · 28,5	10
EMCGV 40-220 LT EMV-Z	10106573	M 40x1,5	8	20 · 22	45	24 · 28,5	10
EMCGV 40-240 LT EMV-Z	10106574	M 40x1,5	8	22 · 24	45	24 · 28,5	10
EMCGV 40-260 LT EMV-Z	10106575	M 40x1,5	8	24 · 26	45	24 · 28,5	10
EMCGV 40-290 LT EMV-Z	10106576	M 40x1,5	8	26 · 29	45	24 · 28,5	10
EMCGV 50-280 LT EMV-Z	10106577	M 50x1,5	9	26 · 28	55	25,5 · 30	10
EMCGV 50-300 LT EMV-Z	10106578	M 50x1,5	9	28 · 30	55	25,5 · 30	10
EMCGV 50-320 LT EMV-Z	10106579	M 50x1,5	9	30 · 32	55	25,5 · 30	10
EMCGV 50-340 LT EMV-Z	10106580	M 50x1,5	9	32 · 34	55	25,5 · 30	10
EMCGV 50-360 LT EMV-Z	10106581	M 50x1,5	9	34 · 36	55	25,5 · 30	10
EMCGV 50-380 LT EMV-Z	10106582	M 50x1,5	9	36 · 38	55	25,5 · 30	10
EMCGV 63-350 LT EMV-Z	10106583	M 63x1,5	10	33 · 35	68	26,5 · 31	10
EMCGV 63-380 LT EMV-Z	10106584	M 63x1,5	10	35 · 38	68	26,5 · 31	10
EMCGV 63-410 LT EMV-Z	10106585	M 63x1,5	10	38 · 41	68	26,5 · 31	10
EMCGV 63-440 LT EMV-Z	10106586	M 63x1,5	10	41 · 44	68	26,5 · 31	10
EMCGV 63-470 LT EMV-Z	10106587	M 63x1,5	10	44 · 47	68	26,5 · 31	10
EMCGV 63-490 LT EMV-Z	10106588	M 63x1,5	10	47 · 49	68	26,5 · 31	10

- KABEL-VER-SCHRAUBUNGEN
- KUNSTSTOFF
- METALL
- MARITIM
- EMV
- EX E / I
- EX D
- RAILWAY
- DRUCKAUSGLEICH / VENTING
- BRITISH STANDARD
- DICH-TÜNGEN
- MEMBRAN-EINFÜHRUNGEN
- MEMBRAN
- KABEL-EINFÜHRUNGSSYSTEM
- CONMAXX
- CONMAXX TEIL-VER-SCHRAUBUNG
- KABEL-SCHUTZ
- BRACE FITTING KUNSTSTOFF
- BRACE CONDUIT KUNSTSTOFF
- BRACE FITTING METALL
- BRACE CONDUIT METALL
- BRACE SLEEVE

SPRINT EMV Erdungseinsätze nach DIN 89345, EE, Messing verchromt





EE



**Hinweis
Material**

* Ähnlich DIN 89345
Messing verchromt

Type	WISKA-No. Cr	 (mm)		
EE 10-03*	50101021	3	HatGLAND 12	1
EE 12-05*	50085887	5	SPRINT 12	1
EE 14-07*	50101022	7	HatGLAND 16	1
EE 16-06	50084648	6	SPRINT 16 / KVM 16	1
EE 16-07*	50085652	7,5	SPRINT 16 / KVM 16	1
EE 18-06	50084649	6	SPRINT20 / KVM18 / HatGLAND20	1
EE 18-07	50080958	7	SPRINT20 / KVM18 / HatGLAND20	1
EE 18-09*	50085650	9,5	SPRINT20 / KVM18 / HatGLAND20	1
EE 22-14*	50101023	14,5	HatGLAND 25	1
EE 24-06	50084650	6	SPRINT 25 / KVM 24	1
EE 24-07	50080960	7	SPRINT 25 / KVM 24	1
EE 24-08	50084651	8	SPRINT 25 / KVM 24	1
EE 24-10	50080962	10,5	SPRINT 25 / KVM 24	1
EE 24-13	50080963	13	SPRINT 25 / KVM 24	1
EE 24-14	50080964	14,5	SPRINT 25 / KVM 24	1
EE 24-16*	50085654	16	SPRINT 25 / KVM 24	1
EE 30-16	50084652	16	SPRINT32 / KVM30 / HatGLAND32	1
EE 30-18	50081743	18	SPRINT32 / KVM30 / HatGLAND32	1
EE 30-20*	50085655	20	SPRINT32 / KVM30 / HatGLAND32	1
EE 36-20	50080967	20	SPRINT40 / KVM36 / HatGLAND40	1
EE 36-22	50084653	22	SPRINT40 / KVM36 / HatGLAND40	1
EE 36-24	50080969	24	SPRINT40 / KVM36 / HatGLAND40	1
EE 36-26*	50085656	26	SPRINT40 / KVM36 / HatGLAND40	1
EE 45-27	50081592	27	SPRINT50 / KVM45 / HatGLAND50	1
EE 45-30	50081407	30	SPRINT50 / KVM45 / HatGLAND50	1
EE 45-33*	50085657	33	SPRINT50 / KVM45 / HatGLAND50	1
EE 56-35	50081406	35	SPRINT63 / KVM56 / HatGLAND63	1
EE 56-39	50080768	39	SPRINT63 / KVM56 / HatGLAND63	1
EE 56-45*	50085658	45	SPRINT63 / KVM56 / HatGLAND63	1
EE 72-49	50080954	49	KVM 72	1
EE 72-44	50080955	44	KVM 72	1
EE 72-58	50085659	58	KVM 72	1
EE 80-62*	50082650	62	KVM 80	1
EE 105-72*	50084654	72	KVM 105	1
EE 105-77*	50084655	77	KVM 105	1

KABEL-
VER-
SCHRAU-
BUNGEN

KUNST-
STOFF

METALL

MARTITIM

EMV

EX E/I

EX D

RAILWAY

DRUCKKAUS-
GLEICH /
VENTING

BRITISH
STANDARD

DICH-
TUNGEN

MEMBRAN-
EINFÜH-
RUNGEN

MEMBRAN

KABEL-
EINFÜH-
RUNGS-
SYSTEM

CONMAXX

CONMAXX
TEILB. VER-
SCHRAU-
BUNG

KABEL-
SCHUTZ

BRACE
FITTING
KUNST-
STOFF

BRACE
CONDUIT
KUNST-
STOFF

BRACE
FITTING
METALL

BRACE
CONDUIT
METALL

BRACE
SLEEVE

EMV Gegenmuttern, Messing vernickelt



EMMU-EMV



MMU-EMV

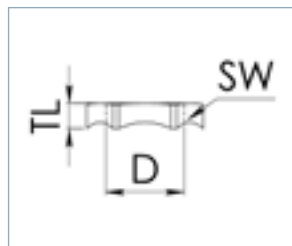

Material

Messing vernickelt

EMMU-EMV, metrisch

Type	WISKA-No. Ni	D (mm)	SW (mm)	TL (mm)	
EMMU-EMV 12	10063210	M 12x1,5	15	4,7	100
EMMU-EMV 16	10063211	M 16x1,5	19	4,7	100
EMMU-EMV 20	10063212	M 20x1,5	24	4,7	100
EMMU-EMV 25	10063213	M 25x1,5	30	5,2	100
EMMU-EMV 32	10063214	M 32x1,5	36	5,7	100
EMMU-EMV 40	10063215	M 40x1,5	46	6,5	50
EMMU-EMV 50	10063216	M 50x1,5	60	7	50
EMMU-EMV 63	10063217	M 63x1,5	70	7	25
EMMU-EMV 75	10102228	M 75x1,5	80	10	1

MMU-EMV, PG

Type	WISKA-No. Ni	D (mm)	SW (mm)	TL (mm)	
MMU-EMV 7	10063218	PG 7	15	4,7	100
MMU-EMV 9	10063219	PG 9	18	4,7	100
MMU-EMV 11	10063220	PG 11	21	4,7	100
MMU-EMV 13,5	10063221	PG 13,5	23	4,7	100
MMU-EMV 16	10063222	PG 16	26	4,7	100
MMU-EMV 21	10063223	PG 21	32	5,2	50
MMU-EMV 29	10063224	PG 29	41	5,7	50
MMU-EMV 36	10063225	PG 36	51	6,5	50
MMU-EMV 42	10063226	PG 42	60	7	50
MMU-EMV 48	10063227	PG 48	64	7	50

SPRINT EMV Kabelverschraubungen mit Erdungseinsatz DIN 89345, ESSKV EMV-Z, Edelstahl, metrisch, EN 62444



ESSKV EMV-Z

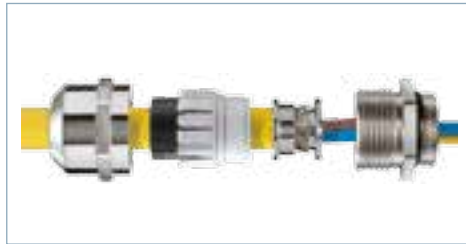



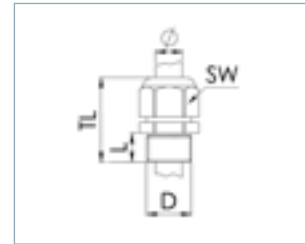



ESSKV-4 EMV-Z









Schutzart IP68 (5 bar 30 min) / IP69
Einsatztemperatur -40 °C · 100 °C
Material Verschraubung Edelstahl A2 (1.4305), Klemmkäfig Polyamid, Dichtung EPDM, Erdungseinsatz Messing verchromt

ESSKV EMV-Z, Edelstahl 1.4305

Type	WISKA-No.						TL (mm)	
ESSKV 12 EMV-Z	10069016	M 12x1,5	5	3 · 7	5	17	23 · 30	10
ESSKV 16 EMV-Z	10069017	M 16x1,5	5	4,5 · 10	7,5	22	26 · 34	10
ESSKV 20 EMV-Z	10069018	M 20x1,5	6	6 · 13	9,5	24	29 · 37	10
ESSKV 25 EMV-Z	10069019	M 25x1,5	7	9 · 17	16	30	33 · 42	10
ESSKV 32 EMV-Z	10069020	M 32x1,5	8	13 · 21	20	36	36 · 44	5
ESSKV 40 EMV-Z	10069021	M 40x1,5	8	16 · 28	26	46	44 · 55	5
ESSKV 50 EMV-Z	10069022	M 50x1,5	9	21 · 35	33	55	51 · 62	2
ESSKV 63 EMV-Z	10069023	M 63x1,5	10	34 · 48	45	68	56 · 67	1

ESSKV-4 EMV-Z, Edelstahl 1.4404

Type	WISKA-No.						TL (mm)	
ESSKV-4 12 EMV-Z	10069116	M 12x1,5	5	3 · 7	5	17	23 · 30	10
ESSKV-4 16 EMV-Z	10069117	M 16x1,5	5	4,5 · 10	7,5	22	26 · 34	10
ESSKV-4 20 EMV-Z	10069118	M 20x1,5	6	6 · 13	9,5	24	29 · 37	10
ESSKV-4 25 EMV-Z	10069119	M 25x1,5	7	9 · 17	16	30	33 · 42	10
ESSKV-4 32 EMV-Z	10069120	M 32x1,5	8	13 · 21	20	36	36 · 44	5
ESSKV-4 40 EMV-Z	10069121	M 40x1,5	8	16 · 28	26	46	44 · 55	5
ESSKV-4 50 EMV-Z	10069122	M 50x1,5	9	21 · 35	33	55	51 · 62	2
ESSKV-4 63 EMV-Z	10069123	M 63x1,5	10	34 · 48	45	68	56 · 67	1

Empfohlenes Zubehör



RDE

BS

ESMU

KABEL-VER-SCHRAU-BUNGEN
 KUNST-STOFF
 METALL
 MARTIM
 EMV
 EX E/I
 EX D
 RAILWAY
 DRUCKKAUS-GLEICH / VENTING
 BRITISH STANDARD
 DICH-TUNGEN
 MEMBRAN-EINFÜH-RUNGEN
 MEMBRAN
 KABEL-EINFÜH-RUNGS-SYSTEM
 CONMAXX
 CONMAXX TEILB. VER-SCHRAU-BUNG
 KABEL-SCHUTZ
 BRACE FITTING KUNST-STOFF
 BRACE CONDUIT KUNST-STOFF
 BRACE FITTING METALL
 BRACE CONDUIT METALL
 BRACE SLEEVE

SPRINT EMV Kontaktfedereinsätze, EMV-S, Edelstahl





EMV-S



Material

Edelstahl 1.4310

Type	WISKA-No.	 (mm)		
EMV-S 12	10102528	2 · 6	SPRINT 12	5
EMV-S 16	10102529	3 · 9	SPRINT 16	5
EMV-S 20	10102530	5 · 12	SPRINT 20	5
EMV-S 25	10102531	7,5 · 13,5	SPRINT 25	5
EMV-S 32	10102532	11 · 19	SPRINT 32	5
EMV-S 40	10102533	14 · 26	SPRINT 40	1
EMV-S 50	10102534	18 · 32	SPRINT 50	1
EMV-S 63	10102535	30 · 44	SPRINT 63	1



EX-Kabelverschraubungen

Für explosionsgefährdete Bereiche auf Ölplattformen, in Gefahrgutlagern oder in der chemischen Industrie haben wir unsere EX-Kabelverschraubungen mit unterschiedlichen Zündschutzarten nach ATEX und IECEx im Angebot. Ob für druckfeste Kapselung, erhöhte Sicherheit oder Eigensicherheit - unser EX-Portfolio reicht von Kabelverschraubungen über Verschlusschrauben und Erweiterungen bis hin zu Adaptern.

SPRINT EX Kabelverschraubungen, ESKE/1-e, erhöhte Sicherheit, Kunststoff, metrisch



ESKE/1-e



ESKE/1-L-e

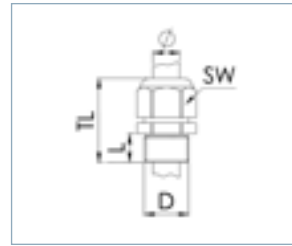

Kennzeichnung II 2 D Ex tb IIIC Db / II 2 G Ex eb IIC Gb
Bescheinigung IECEx PTB 13.0034X / PTB 13 ATEX 1015 X
Schutzart IP66 / IP68 (5 bar 30 min)
Glühdrahtprüfung 750 °C
Einsatztemperatur -40 °C · 75 °C
Material Verschraubung Polyamid, Dichtung EPDM

ESKE/1-e

Type	WISKA-No. RAL 9005 BK	D (mm)	L (mm)	Ø (mm)	SW (mm)	TL (mm)	
ESKE/1-e 12	10103363	M 12x1,5	9	3 · 6	16	29 · 34	50
ESKE/1-e 16	10103364	M 16x1,5	9	4,5 · 9	20	31 · 37	50
ESKE/1-e 20	10103365	M 20x1,5	10	7 · 13	24	36 · 45	50
ESKE/1-e 25	10103366	M 25x1,5	10	10 · 17	29	38 · 47	50
ESKE/1-e 32	10103367	M 32x1,5	12	13 · 21	36	42 · 51	25
ESKE/1-e 40	10103368	M 40x1,5	12	17 · 28	46	52 · 65	10
ESKE/1-e 50	10103369	M 50x1,5	14	23 · 35	55	59 · 72	4
ESKE/1-e 63	10103370	M 63x1,5	15	34 · 48	68	64 · 78	1

ESKE/1-L-e, lang

Type	WISKA-No. RAL 9005 BK	D (mm)	L (mm)	Ø (mm)	SW (mm)	TL (mm)	
ESKE/1-L-e 12	10103379	M 12x1,5	15	3 · 6	16	35 · 40	50
ESKE/1-L-e 16	10103380	M 16x1,5	15	4,5 · 9	20	37 · 43	50
ESKE/1-L-e 20	10103381	M 20x1,5	15	7 · 13	24	41 · 48	50
ESKE/1-L-e 25	10103382	M 25x1,5	15	10 · 17	29	43 · 51	50
ESKE/1-L-e 32	10103383	M 32x1,5	15	13 · 21	36	45 · 53	25
ESKE/1-L-e 40	10103384	M 40x1,5	18	17 · 28	46	58 · 71	10
ESKE/1-L-e 50	10103385	M 50x1,5	18	23 · 35	55	63 · 76	4
ESKE/1-L-e 63	10103386	M 63x1,5	18	34 · 48	68	67 · 81	1

Empfohlenes Zubehör



EMUG

RDE

BS

MFD RW

SPRINT EX Kabelverschraubungen LowTemp, ESKE/1-e LT, erhöhte Sicherheit, Kunststoff, metrisch



ESKE/1-e LT



ESKE/1-L-e LT

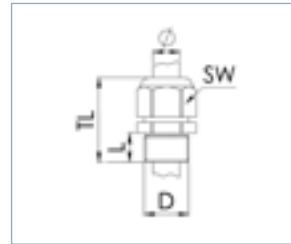

Kennzeichnung II 2 D Ex tb IIIC Db / II 2 G Ex eb IIC Gb
Bescheinigung IECEx PTB 13.0034X / PTB 13 ATEX 1015 X
Schutzart IP66 / IP68 (5 bar 30 min)
Glühdrahtprüfung 750 °C
Einsatztemperatur -60 °C · 75 °C
Material Verschraubung Polyamid, Dichtung Silikon

ESKE/1-e LT

Type	WISKA-No. RAL 9005 BK	D (mm)	L (mm)	Ø (mm)	SW (mm)	TL (mm)	
ESKE/1-e 12 LT	10103429	M 12x1,5	9	3 · 6	16	29 · 34	50
ESKE/1-e 16 LT	10103430	M 16x1,5	9	4,5 · 9	20	31 · 37	50
ESKE/1-e 20 LT	10103431	M 20x1,5	10	7 · 13	24	36 · 45	50
ESKE/1-e 25 LT	10103432	M 25x1,5	10	10 · 17	29	38 · 47	50
ESKE/1-e 32 LT	10103433	M 32x1,5	12	13 · 21	36	42 · 51	25
ESKE/1-e 40 LT	10103434	M 40x1,5	12	17 · 28	46	52 · 65	10
ESKE/1-e 50 LT	10103435	M 50x1,5	14	23 · 35	55	59 · 72	4
ESKE/1-e 63 LT	10103436	M 63x1,5	15	34 · 48	68	64 · 78	1

ESKE/1-L-e LT, lang

Type	WISKA-No. RAL 9005 BK	D (mm)	L (mm)	Ø (mm)	SW (mm)	TL (mm)	
ESKE/1-L-e 12 LT	10103445	M 12x1,5	15	3 · 6	16	35 · 40	50
ESKE/1-L-e 16 LT	10103446	M 16x1,5	15	4,5 · 9	20	37 · 43	50
ESKE/1-L-e 20 LT	10103447	M 20x1,5	15	7 · 13	24	41 · 48	50
ESKE/1-L-e 25 LT	10103448	M 25x1,5	15	10 · 17	29	43 · 51	50
ESKE/1-L-e 32 LT	10103449	M 32x1,5	15	13 · 21	36	45 · 53	25
ESKE/1-L-e 40 LT	10103450	M 40x1,5	18	17 · 28	46	58 · 71	10
ESKE/1-L-e 50 LT	10103451	M 50x1,5	18	23 · 35	55	63 · 76	4
ESKE/1-L-e 63 LT	10103452	M 63x1,5	18	34 · 48	68	67 · 81	1

Empfohlenes Zubehör



EMUG

RDE LT

BS

MFD RW

KABEL-
VER-
SCHRAU-
BUNGEN
 KUNST-
STOFF
 METALL
 MARTINI
 ENV
 EX E/I
 EX D
 RAILWAY
 DRUCKAUS-
GLEICH /
VENTING
 BRITISH
STANDARD
 DICH-
TUNGEN
 MEMBRAN-
EINFÜH-
RUNGEN
 MEMBRAN
 KABEL-
EINFÜH-
RUNGS-
SYSTEM
 CONMAXX
 CONMAXX
TEILB. VER-
SCHRAU-
BUNG
 KABEL-
SCHUTZ
 BRACE
FITTING
KUNST-
STOFF
 BRACE
CONDUIT
KUNST-
STOFF
 BRACE
FITTING
METALL
 BRACE
CONDUIT
METALL
 BRACE
SLEEVE

SPRINT EX Kabelverschraubungen mit Knickschutz, ESKE/1S-e, erhöhte Sicherheit, Kunststoff, metrisch



ESKE/1S-e



ESKE/1S-L-e

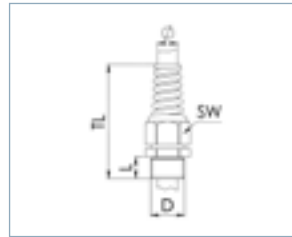

Kennzeichnung II 2 D Ex tb IIIC Db / II 2 G Ex eb IIC Gb
Bescheinigung IECEx PTB 13.0034X / PTB 13 ATEX 1015 X
Schutzart IP66 / IP68 (5 bar 30 min)
Glühdrahtprüfung 750 °C
Einsatztemperatur -40 °C · 75 °C
Material Verschraubung Polyamid, Dichtung EPDM

ESKE/1S-e

Type	WISKA-No. RAL 9005 BK					TL (mm)	
ESKE/1S-e 12	10103493	M 12x1,5	9	3 · 6	16	72 · 77	50
ESKE/1S-e 16	10103494	M 16x1,5	9	4,5 · 9	20	82 · 88	50
ESKE/1S-e 20	10103495	M 20x1,5	10	7 · 13	24	103 · 112	50
ESKE/1S-e 25	10103496	M 25x1,5	10	10 · 17	29	119 · 128	25
ESKE/1S-e 32	10103497	M 32x1,5	12	13 · 21	36	138 · 147	10

ESKE/1S-L-e, lang

Type	WISKA-No. RAL 9005 BK					TL (mm)	
ESKE/1S-L-e 12	10103503	M 12x1,5	15	3 · 6	16	78 · 83	50
ESKE/1S-L-e 16	10103504	M 16x1,5	15	4,5 · 9	20	88 · 94	50
ESKE/1S-L-e 20	10103505	M 20x1,5	15	7 · 13	24	108 · 117	50
ESKE/1S-L-e 25	10103506	M 25x1,5	15	10 · 17	29	124 · 133	50
ESKE/1S-L-e 32	10103507	M 32x1,5	15	13 · 21	36	141 · 150	10

Empfohlenes Zubehör



EMUG

RDE

BS

MFD RW

SPRINT EX Kabelverschraubungen, ESKE/1-i, Eigensicherheit, Kunststoff, metrisch



ESKE/1-i



ESKE/1-L-i

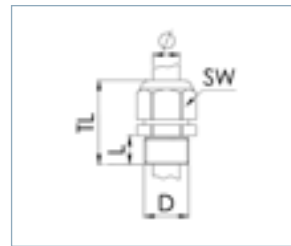

Kennzeichnung	II 2 D Ex tb IIIC Db / II 2 G Ex eb IIC Gb
Bescheinigung	IECEx PTB 13.0034X · PTB 13 ATEX 1015 X
Schutzart	IP66 / IP68 (5 bar 30 min)
Glühdrahtprüfung	750 °C
Einsatztemperatur	-40 °C · 75 °C
Farbe	RAL 5012/9005
Material	Verschraubung Polyamid, Dichtung EPDM

ESKE/1-i

Type	WISKA-No. RAL 9005 BK	D (mm)	L (mm)	Ø (mm)	SW (mm)	TL (mm)	
ESKE/1-i 12	10103371	M 12x1,5	9	3 · 6	16	31 · 37	50
ESKE/1-i 16	10103372	M 16x1,5	9	4,5 · 9	20	31 · 37	50
ESKE/1-i 20	10103373	M 20x1,5	10	7 · 13	24	36 · 45	50
ESKE/1-i 25	10103374	M 25x1,5	10	10 · 17	29	38 · 47	50
ESKE/1-i 32	10103375	M 32x1,5	12	13 · 21	36	42 · 51	25
ESKE/1-i 40	10103376	M 40x1,5	12	17 · 28	46	52 · 65	10
ESKE/1-i 50	10103377	M 50x1,5	14	23 · 35	55	59 · 72	4
ESKE/1-i 63	10103378	M 63x1,5	15	34 · 48	68	64 · 78	1

ESKE/1-L-i, lang

Type	WISKA-No. RAL 9005 BK	D (mm)	L (mm)	Ø (mm)	SW (mm)	TL (mm)	
ESKE/1-L-i 12	10103387	M 12x1,5	15	3 · 6	16	35 · 45	50
ESKE/1-L-i 16	10103388	M 16x1,5	15	4,5 · 9	20	37 · 43	50
ESKE/1-L-i 20	10103389	M 20x1,5	15	7 · 13	24	41 · 48	50
ESKE/1-L-i 25	10103390	M 25x1,5	15	10 · 17	29	43 · 51	50
ESKE/1-L-i 32	10103391	M 32x1,5	15	13 · 21	36	45 · 53	25
ESKE/1-L-i 40	10103392	M 40x1,5	18	17 · 28	46	58 · 71	10
ESKE/1-L-i 50	10103393	M 50x1,5	18	23 · 35	55	63 · 76	4
ESKE/1-L-i 63	10103394	M 63x1,5	18	34 · 48	68	67 · 81	1

Empfohlenes Zubehör



EMUG

RDE

BS

MFD RW

KABEL-VER-SCHRAUBUNGEN
KUNST-STOFF
METALL
MARTITIM
ENV
EX E/i
EX D
RAILWAY
BRÜCKAUS-GLEICH / VENTING
BRITISH STANDARD
DICH-TUNGEN
MEMBRAN-EINFÜH-RUNGEN
KABEL-EINFÜH-RUNGS-SYSTEM
CONMAXX
CONMAXX TELLB-VER-SCHRAU-BUNG
KABEL-SCHUTZ
BRACE FITTING KUNST-STOFF
BRACE CONDUIT KUNST-STOFF
BRACE FITTING METALL
BRACE CONDUIT METALL
BRACE SLEEVE

SPRINT EX Kabelverschraubungen LowTemp, ESKE/1-i LT, Eigensicherheit, Kunststoff, metrisch



ESKE/1-i LT



ESKE/1-L-i LT

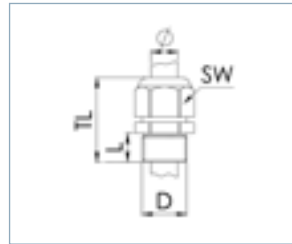

Kennzeichnung II 2 D Ex tb IIIC Db / II 2 G Ex eb IIC Gb
Bescheinigung IECEx PTB 13.0034X / PTB 13 ATEX 1015 X
Schutzart IP66 / IP68 (5 bar 30 min)
Glühdrahtprüfung 750 °C
Einsatztemperatur -60 °C · 75 °C
Farbe RAL 5012/9005
Material Verschraubung Polyamid, Dichtung Silikon

ESKE/1-i LT

Type	WISKA-No. RAL 9005 BK					TL (mm)	
ESKE/1-i 12 LT	10103437	M 12x1,5	9	3 · 6	16	31 · 37	50
ESKE/1-i 16 LT	10103438	M 16x1,5	9	4,5 · 9	20	31 · 37	50
ESKE/1-i 20 LT	10103439	M 20x1,5	10	7 · 13	24	36 · 45	50
ESKE/1-i 25 LT	10103440	M 25x1,5	10	10 · 17	29	38 · 47	50
ESKE/1-i 32 LT	10103441	M 32x1,5	12	13 · 21	36	42 · 51	25
ESKE/1-i 40 LT	10103442	M 40x1,5	12	17 · 28	46	52 · 65	10
ESKE/1-i 50 LT	10103443	M 50x1,5	14	23 · 35	55	59 · 72	4
ESKE/1-i 63 LT	10103444	M 63x1,5	15	34 · 48	68	64 · 78	1

ESKE/1-L-i LT, lang

Type	WISKA-No. RAL 9005 BK					TL (mm)	
ESKE/1-L-i 12 LT	10103453	M 12x1,5	15	3 · 6	16	35 · 45	50
ESKE/1-L-i 16 LT	10103454	M 16x1,5	15	4,5 · 9	20	37 · 43	50
ESKE/1-L-i 20 LT	10103455	M 20x1,5	15	7 · 13	24	41 · 48	50
ESKE/1-L-i 25 LT	10103456	M 25x1,5	15	10 · 17	29	43 · 51	50
ESKE/1-L-i 32 LT	10103457	M 32x1,5	15	13 · 21	36	45 · 53	25
ESKE/1-L-i 40 LT	10103458	M 40x1,5	18	17 · 28	46	58 · 71	10
ESKE/1-L-i 50 LT	10103459	M 50x1,5	18	23 · 35	55	63 · 76	4
ESKE/1-L-i 63 LT	10103460	M 63x1,5	18	34 · 48	68	67 · 81	1

Empfohlenes Zubehör



EMUG

RDE LT

BS

MFD RW

EX Verschlusschrauben, EX-EVSG, Kunststoff, metrisch



EX-EVSG

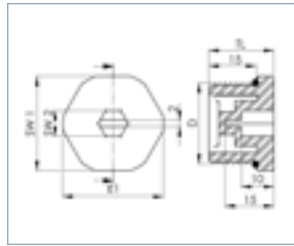

Kennzeichnung II 2 D Ex tb IIIC Db / II 2 G Ex eb IIC Gb
Bescheinigung PTB 06 ATEX 1032 X / IECEx PTB 16.0025X
Schutzart IP66 / IP68 (5 bar 30 min)
Einsatztemperatur -40 °C - 75 °C
Material Polyamid, Dichtung EPDM

Type	WISKA-No. RAL 9005 BK	D (mm)	L (mm)	SW 1 (mm)	SW 2 (mm)	TL (mm)	
EX-EVSG 12	10065300	M 12x1,5	15	16	6	19	100
EX-EVSG 16	10065301	M 16x1,5	15	20	8	19	100
EX-EVSG 20	10065302	M 20x1,5	15	24	8	19	100
EX-EVSG 25	10065303	M 25x1,5	15	29	8	20	100
EX-EVSG 32	10065304	M 32x1,5	15	36	8	20	50
EX-EVSG 40	10065305	M 40x1,5	15	46	8	20	30
EX-EVSG 50	10065306	M 50x1,5	15	55	8	20	30
EX-EVSG 63	10065307	M 63x1,5	15	68	8	20	30
EX-EVSG 75	10065308	M 75x1,5	15	82	8	20	2

Empfohlenes Zubehör



KABEL-
VER-
SCHRAU-
BUNGEN

KUNST-
STOFF

METALL

MARTITIM

ENV

EX E/I

EX D

RAILWAY

BRÜCKEN-
GLEICH /
VENTING

BRITISH
STANDARD

DICH-
TUNGEN

MEMBRAN-
EINFÜH-
RUNGEN

MEMBRAN

KABEL-
EINFÜH-
RUNGS-
SYSTEM

CONMAXX

CONMAXX
TEILB. VER-
SCHRAU-
BUNG

KABEL-
SCHUTZ

BRACE
FITTING
KUNST-
STOFF

BRACE
CONDUIT
KUNST-
STOFF

BRACE
FITTING
METALL

BRACE
CONDUIT
METALL

BRACE
SLEEVE

EX Erweiterungen, EX-KEM, Kunststoff, metrisch-metrisch

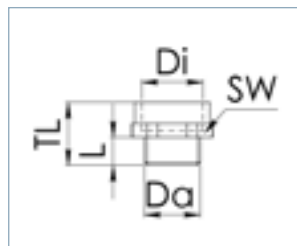

EX-KEM



Kennzeichnung II 2 D Ex tb IIIC Db / II 2 G Ex eb IIC Gb
Bescheinigung PTB 04 ATEX 1040 X / IECEx PTB 16.0026X
Schutzart IP66
Einsatztemperatur -20 °C - 70 °C
Material Polyamid, glasfaserverstärkt

Type	WISKA-No. RAL 9005 BK	Da (mm)	Di (mm)	TL (mm)	SW (mm)	TL (mm)	
EX-KEM 12/16	10064741	M 12x1,5	M 16x1,5	9	20	27	100
EX-KEM 16/20	10064742	M 16x1,5	M 20x1,5	9	24	27	100
EX-KEM 20/25	10064743	M 20x1,5	M 25x1,5	9	29	27	100
EX-KEM 25/32	10064744	M 25x1,5	M 32x1,5	10	36	28	100
EX-KEM 32/40	10064745	M 32x1,5	M 40x1,5	12	46	30	50
EX-KEM 40/50	10064746	M 40x1,5	M 50x1,5	12	55	30	25
EX-KEM 50/63	10064747	M 50x1,5	M 63x1,5	14	68	32	5

Empfohlenes Zubehör



EX Reduzierungen, EX-KRM, Kunststoff, metrisch-metrisch



EX-KRM Form A



EX-KRM Form B

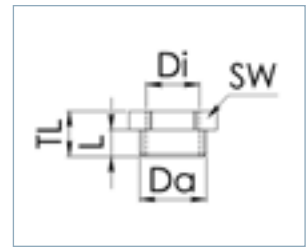
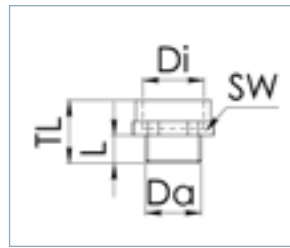

Kennzeichnung II 2 D Ex tb IIIC Db / II 2 G Ex eb IIC Gb
Bescheinigung PTB 04 ATEX 1040 X / IECEx PTB 16.0026X
Schutzart IP66
Einsatztemperatur -20 °C - 70 °C
Material Polyamid, glasfaserverstärkt

Type	WISKA-No. RAL 9005 BK	Da (mm)	Di (mm)	L (mm)	SW (mm)	TL (mm)	Form	
EX-KRM 16/12	10064720	M 16x1,5	M 12x1,5	9	20	27	A	100
EX-KRM 20/12	10064721	M 20x1,5	M 12x1,5	9	24	16	B	100
EX-KRM 20/16	10064722	M 20x1,5	M 16x1,5	9	24	27	A	100
EX-KRM 25/12	10064723	M 25x1,5	M 12x1,5	10	29	17	B	100
EX-KRM 25/16	10064724	M 25x1,5	M 16x1,5	10	29	17	B	100
EX-KRM 25/20	10064725	M 25x1,5	M 20x1,5	10	29	17	B	100
EX-KRM 32/16	10064726	M 32x1,5	M 16x1,5	12	36	19	B	50
EX-KRM 32/20	10064727	M 32x1,5	M 20x1,5	12	36	19	B	50
EX-KRM 32/25	10064728	M 32x1,5	M 25x1,5	12	36	19	B	50
EX-KRM 40/20	10064729	M 40x1,5	M 20x1,5	12	46	19	B	25
EX-KRM 40/25	10064730	M 40x1,5	M 25x1,5	12	46	19	B	25
EX-KRM 40/32	10064731	M 40x1,5	M 32x1,5	12	46	19	B	25
EX-KRM 50/20	10064732	M 50x1,5	M 20x1,5	14	55	21	B	5
EX-KRM 50/25	10064733	M 50x1,5	M 25x1,5	14	55	21	B	5
EX-KRM 50/32	10064734	M 50x1,5	M 32x1,5	14	55	21	B	5
EX-KRM 50/40	10064735	M 50x1,5	M 40x1,5	14	55	21	B	5
EX-KRM 63/20	10064736	M 63x1,5	M 20x1,5	15	68	22	B	5
EX-KRM 63/25	10064737	M 63x1,5	M 25x1,5	15	68	22	B	5
EX-KRM 63/32	10064738	M 63x1,5	M 32x1,5	15	68	22	B	5
EX-KRM 63/40	10064739	M 63x1,5	M 40x1,5	15	68	22	B	5
EX-KRM 63/50	10064740	M 63x1,5	M 50x1,5	15	68	22	B	5

Empfohlenes Zubehör



EMUG

KABEL-
VER-
SCHRAU-
BUNGEN
KUNST-
STOFF
METALL
MARITIM
ENV
EX E/I
EX D
RAILWAY
BRÜCKEN-
GLEICH /
VENTING
BRITISH
STANDARD
DICH-
TUNGEN
MEMBRAN-
EINFÜH-
RUNGEN
MEMBRAN
KABEL-
EINFÜH-
RUNGS-
SYSTEM
CONMAXX
CONMAXX
TEILB. VER-
SCHRAU-
BUNG
KABEL-
SCHUTZ
BRACE
FITTING
KUNST-
STOFF
BRACE
CONDUIT
KUNST-
STOFF
BRACE
FITTING
METALL
BRACE
CONDUIT
METALL
BRACE
SLEEVE

EX Adapter, EX-APM, Kunststoff, PG-metrisch



EX-APM Form A



EX-APM Form B

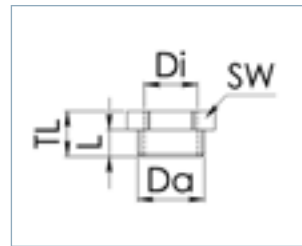
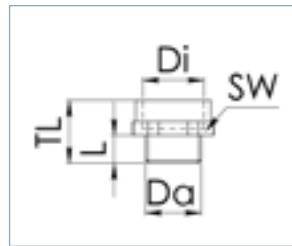

Kennzeichnung II 2 D Ex tb IIIC Db / II 2 G Ex eb IIC Gb
Bescheinigung PTB 04 ATEX 1040 X / IECEx PTB 16.0026X
Schutzart IP66
Einsatztemperatur -20 °C - 70 °C
Material Polyamid, glasfaserverstärkt

Type	WISKA-No. RAL 9005 BK					TL (mm)	Form	
EX-APM 7/12	10064748	PG 7	M 12x1,5	9	16	27	A	25
EX-APM 7/16	10064749	PG 7	M 16x1,5	9	20	27	A	25
EX-APM 9/12	10064750	PG 9	M 12x1,5	9	20	27	A	25
EX-APM 9/16	10064751	PG 9	M 16x1,5	9	20	27	A	25
EX-APM 9/20	10064752	PG 9	M 20x1,5	9	24	27	A	25
EX-APM 11/16	10064753	PG 11	M 16x1,5	9	22	27	A	25
EX-APM 11/20	10064754	PG 11	M 20x1,5	9	24	27	A	25
EX-APM 11/25	10064755	PG 11	M 25x1,5	9	29	27	A	25
EX-APM 13,5/16	10064756	PG 13,5	M 16x1,5	10	24	28	A	25
EX-APM 13,5/20	10064757	PG 13,5	M 20x1,5	10	24	28	A	25
EX-APM 13,5/25	10064758	PG 13,5	M 25x1,5	10	29	28	A	25
EX-APM 16/20	10064759	PG 16	M 20x1,5	10	27	28	A	25
EX-APM 16/25	10064760	PG 16	M 25x1,5	10	29	28	A	25
EX-APM 16/32	10064761	PG 16	M 32x1,5	10	36	28	A	25
EX-APM 21/20	10064762	PG 21	M 20x1,5	12	33	19	B	10
EX-APM 21/25	10064763	PG 21	M 25x1,5	12	33	30	A	10
EX-APM 21/32	10064764	PG 21	M 32x1,5	12	36	30	A	10
EX-APM 21/40	10064765	PG 21	M 40x1,5	12	46	30	A	10
EX-APM 29/20	10064766	PG 29	M 20x1,5	12	42	19	B	10
EX-APM 29/25	10064767	PG 29	M 25x1,5	12	42	19	B	10
EX-APM 29/32	10064768	PG 29	M 32x1,5	12	42	19	B	10
EX-APM 29/40	10064769	PG 29	M 40x1,5	12	46	30	A	10
EX-APM 29/50	10064770	PG 29	M 50x1,5	12	55	30	A	10
EX-APM 36/20	10064771	PG 36	M 20x1,5	14	53	21	B	10
EX-APM 36/25	10064772	PG 36	M 25x1,5	14	53	21	B	10
EX-APM 36/32	10064773	PG 36	M 32x1,5	14	53	21	B	10
EX-APM 36/40	10064774	PG 36	M 40x1,5	14	53	21	B	10
EX-APM 36/50	10064775	PG 36	M 50x1,5	14	55	32	A	10
EX-APM 36/63	10064776	PG 36	M 63x1,5	14	68	32	A	10
EX-APM 42/20	10064777	PG 42	M 20x1,5	14	60	21	B	5
EX-APM 42/25	10064778	PG 42	M 25x1,5	14	60	21	B	5
EX-APM 42/32	10064779	PG 42	M 32x1,5	14	60	21	B	5
EX-APM 42/40	10064780	PG 42	M 40x1,5	14	60	21	B	5
EX-APM 42/50	10064781	PG 42	M 50x1,5	14	60	32	A	5
EX-APM 42/63	10064782	PG 42	M 63x1,5	14	68	32	A	5
EX-APM 48/20	10064783	PG 48	M 20x1,5	15	65	22	B	5
EX-APM 48/25	10064784	PG 48	M 25x1,5	15	65	22	B	5
EX-APM 48/32	10064785	PG 48	M 32x1,5	15	65	22	B	5
EX-APM 48/40	10064786	PG 48	M 40x1,5	15	65	22	B	5
EX-APM 48/50	10064787	PG 48	M 50x1,5	15	65	22	B	5
EX-APM 48/63	10064788	PG 48	M 63x1,5	15	68	33	A	5

SPRINT EX Kabelverschraubungen, EMSKE, Messing vernickelt, metrisch



EMSKE



EMSKE-L

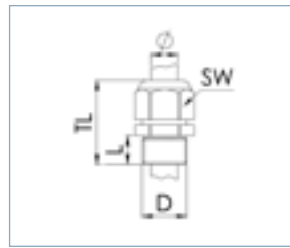

Kennzeichnung II 2 D Ex tb IIIC Db / II 2 G Ex eb IIC Gb
Bescheinigung IECEx PTB 13.0027X / PTB 04 ATEX 1112 X
Schutzart IP66 / IP68 (5 bar 30 min)
Einsatztemperatur -40 °C - 75 °C
Material Verschraubung Messing vernickelt, Klemmkäfig Polyamid, Dichtung EPDM

EMSKE

Type	WISKA-No. Ni					TL (mm)	
EMSKE 12	10065040	M 12x1,5	5	4 · 7	16	23 · 30	50
EMSKE 16	10065041	M 16x1,5	5	5 · 10	20	26 · 34	50
EMSKE 20	10065042	M 20x1,5	6	6 · 13	24	29 · 37	50
EMSKE 25	10065043	M 25x1,5	7	10 · 17	29	33 · 42	50
EMSKE 32	10065044	M 32x1,5	8	13 · 21	36	36 · 44	25
EMSKE 40	10065045	M 40x1,5	8	16 · 28	46	44 · 55	10
EMSKE 50	10065046	M 50x1,5	9	21 · 35	55	51 · 62	10
EMSKE 63	10065047	M 63x1,5	10	34 · 48	68	56 · 67	10
EMSKE 75	10104386	M 75x1,5	12	48 · 62	82	67 · 81	1

EMSKE-L, lang

Type	WISKA-No. Ni					TL (mm)	
EMSKE-L 12	10065048	M 12x1,5	12	4 · 7	16	30 · 37	50
EMSKE-L 16	10065049	M 16x1,5	12	5 · 10	20	33 · 41	50
EMSKE-L 20	10065050	M 20x1,5	12	6 · 13	24	35 · 43	50
EMSKE-L 25	10065051	M 25x1,5	12	10 · 17	29	38 · 47	50
EMSKE-L 32	10065052	M 32x1,5	15	13 · 21	36	43 · 51	25
EMSKE-L 40	10065053	M 40x1,5	15	16 · 28	46	51 · 62	10
EMSKE-L 50	10065054	M 50x1,5	15	21 · 35	55	57 · 68	10
EMSKE-L 63	10065055	M 63x1,5	15	34 · 48	68	61 · 72	10

Empfohlenes Zubehör



RDE

EMMU

BS

MFD RW

KABEL-
 VER-
 SCHRAU-
 BUNGEN
 KUNST-
 STOFF
 METALL
 MARTITIM
 ENV
 EX E/I
 EX D
 RAILWAY
 BRÜCKEN-
 DRUCKHAUS-
 GLEICH /
 VENTING
 BRITISH
 STANDARD
 DICH-
 TUNGEN
 MEMBRAN-
 EINFÜH-
 RUNGEN
 MEMBRAN
 KABEL-
 EINFÜH-
 RUNGS-
 SYSTEM
 CONMAXX
 CONMAXX
 TEILB. VER-
 SCHRAU-
 BUNG
 KABEL-
 SCHUTZ
 BRACE
 FITTING
 KUNST-
 STOFF
 BRACE
 CONDUIT
 KUNST-
 STOFF
 BRACE
 FITTING
 METALL
 BRACE
 CONDUIT
 METALL
 BRACE
 SLEEVE

SPRINT EX Kabelverschraubungen LowTemp, EMSKE LT, Messing vernickelt, metrisch



EMSKE LT





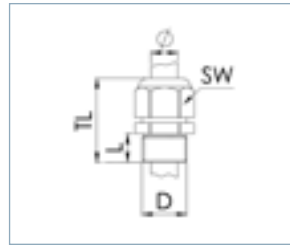

EMSKE-L LT







Kennzeichnung II 2 D Ex tb IIIC Db / II 2 G Ex eb IIC Gb
Bescheinigung IECEx PTB 13.0027X / PTB 04 ATEX 1112 X
Schutzart IP66 / IP68 (5 bar 30 min)
Einsatztemperatur -60 °C - 75 °C
Material Verschraubung Messing vernickelt, Klemmkäfig Polyamid, Dichtung Silikon

EMSKE LT

Type	WISKA-No. Ni	 D (mm)	 (mm)	 (mm)	 SW (mm)	TL (mm)	
EMSKE 12 LT	10065946	M 12x1,5	5	4 · 7	16	23 · 30	50
EMSKE 16 LT	10065947	M 16x1,5	5	5 · 10	20	26 · 34	50
EMSKE 20 LT	10065948	M 20x1,5	6	6 · 13	24	29 · 37	50
EMSKE 25 LT	10065949	M 25x1,5	7	10 · 17	29	33 · 42	50
EMSKE 32 LT	10065950	M 32x1,5	8	13 · 21	36	36 · 44	25
EMSKE 40 LT	10065951	M 40x1,5	8	16 · 28	46	44 · 55	10
EMSKE 50 LT	10065952	M 50x1,5	9	21 · 35	55	51 · 62	10
EMSKE 63 LT	10065953	M 63x1,5	10	34 · 48	68	56 · 67	10

EMSKE-L LT, lang

Type	WISKA-No. Ni	 D (mm)	 (mm)	 (mm)	 SW (mm)	TL (mm)	
EMSKE-L 12 LT	10065938	M 12x1,5	12	4 · 7	16	30 · 37	50
EMSKE-L 16 LT	10065939	M 16x1,5	12	5 · 10	20	33 · 41	50
EMSKE-L 20 LT	10065940	M 20x1,5	12	6 · 13	24	35 · 43	50
EMSKE-L 25 LT	10065941	M 25x1,5	12	10 · 17	29	38 · 47	50
EMSKE-L 32 LT	10065942	M 32x1,5	15	13 · 21	36	43 · 51	25
EMSKE-L 40 LT	10065943	M 40x1,5	15	16 · 28	46	51 · 62	10
EMSKE-L 50 LT	10065944	M 50x1,5	15	21 · 35	55	57 · 68	10
EMSKE-L 63 LT	10065945	M 63x1,5	15	34 · 48	68	61 · 72	10

Empfohlenes Zubehör



EMMU

RDE LT

BS

MFD RW





SPRINT EX Kabelverschraubungen, NMSKE, Messing vernickelt, NPT

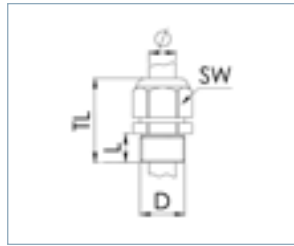

NMSKE



Kennzeichnung II 2 D Ex tb IIIC Db / II 2 G Ex eb IIC Gb
Bescheinigung IECEx PTB 13.0027X / PTB 04 ATEX 1112 X
Schutzart IP66 / IP68 (5 bar 30 min)
Einsatztemperatur -40 °C - 75 °C
Material Verschraubung Messing vernickelt, Klemmkäfig Polyamid, Dichtung EPDM

Type	WISKA-No. Ni	 D (mm)	 L (mm)	 (mm)	 SW (mm)	TL (mm)	
NMSKE 1/4	10101082	NPT 1/4"	13	4 - 7	16	33 - 40	50
NMSKE 3/8	10101083	NPT 3/8"	13	5 - 10	20	35 - 42	50
NMSKE 1/2	10101084	NPT 1/2"	16	6 - 13	24	38 - 45	50
NMSKE 3/4	10101085	NPT 3/4"	16	10 - 17	29	40 - 48	50
NMSKE 1	10101086	NPT 1"	20	13 - 21	36	46 - 53	25
NMSKE 1 1/4	10101087	NPT 1 1/4"	20	16 - 28	46	50 - 58	10
NMSKE 1 1/2	10101088	NPT 1 1/2"	20	21 - 35	55	51 - 62	10
NMSKE 2	10101089	NPT 2"	21	34 - 48	68	56 - 67	10

Empfohlenes Zubehör



ADR

RDE

BS

NMMU

KABEL-
VER-
SCHRAU-
BUNGEN
 KUNST-
STOFF
 METALL
 MARTITIM
 ENV
 EX E/I
 EX D
 RAILWAY
 BRÜCKEN-
GLEICH /
VENTING
 BRITISH
STANDARD
 DICH-
TUNGEN
 MEMBRAN-
EINFÜH-
RUNGEN
 MEMBRAN
 KABEL-
EINFÜH-
RUNGS-
SYSTEM
 CONMAXX
 CONMAXX
TEILB. VER-
SCHRAU-
BUNG
 KABEL-
SCHUTZ
 BRACE
FITTING
KUNST-
STOFF
 BRACE
CONDUIT
KUNST-
STOFF
 BRACE
FITTING
METALL
 BRACE
CONDUIT
METALL
 BRACE
SLEEVE

SPRINT EX EMV Kabelverschraubungen mit Kontaktfedereinsatz, EMSKE EMV-S, Messing vernickelt, metrisch

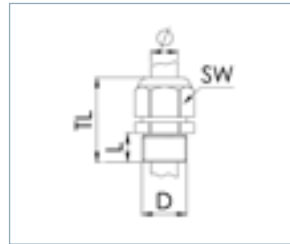

EMSKE EMV-S

**Kennzeichnung**

II 2 D Ex tb IIIC Db / II 2 G Ex eb IIC Gb

Bescheinigung

IECEx PTB 13.0027X · PTB 04 ATEX 1112 X

Schutzart

IP66 / IP68 (5 bar 30 min)

Einsatztemperatur

-40 °C · 75 °C

Material

Verschraubung Messing vernickelt, Klemmkäfig Polyamid, Kontaktfedereinsatz Edelstahl 1.4310, Dichtung EPDM

Type	WISKA-No. Ni	D (mm)	L (mm)	(mm)	(mm)	SW (mm)	TL (mm)	
EMSKE 12 EMV-S	10102971	M 12x1,5	5	4 - 7	5	16	23 - 30	50
EMSKE 16 EMV-S	10102972	M 16x1,5	5	4,5 - 10	7,5	20	26 - 34	50
EMSKE 20 EMV-S	10102973	M 20x1,5	6	6 - 13	9,5	24	29 - 37	50
EMSKE 25 EMV-S	10102974	M 25x1,5	7	10 - 17	16	29	33 - 42	50
EMSKE 32 EMV-S	10102975	M 32x1,5	8	13 - 21	20	36	36 - 44	25
EMSKE 40 EMV-S	10102976	M 40x1,5	8	16 - 28	26	46	44 - 55	10
EMSKE 50 EMV-S	10102977	M 50x1,5	9	21 - 35	33	55	51 - 62	10
EMSKE 63 EMV-S	10102978	M 63x1,5	10	34 - 48	45	68	56 - 67	10

Empfohlenes Zubehör

RDE

EMMU-EMV

BS

SPRINT EX EMV Kabelverschraubungen mit Erdungseinsatz DIN 89345, EMSKE EMV-Z, Messing vernickelt, metrisch

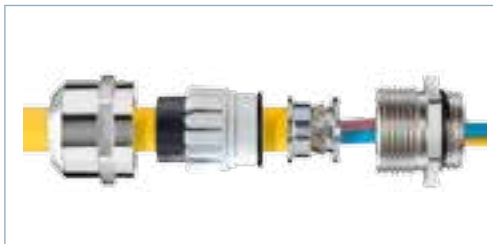

EMSKE EMV-Z

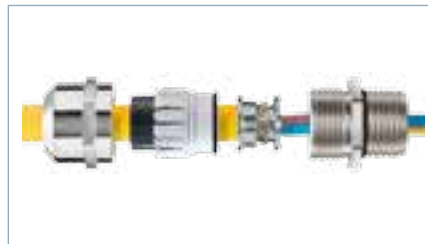

EMSKE-L EMV-Z

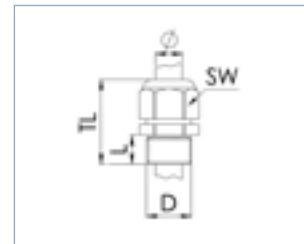

Kennzeichnung	II 2 D Ex tb IIIC Db / II 2 G Ex eb IIC Gb
Bescheinigung	IECEx PTB 13.0027X / PTB 04 ATEX 1112 X
Schutzart	IP66 / IP68 (5 bar 30 min)
Einsatztemperatur	-40 °C - 75 °C
Material	Verschraubung Messing vernickelt, Klemmkäfig Polyamid, Erdungseinsatz Messing verchromt, Dichtung EPDM

EMSKE EMV-Z

Type	WISKA-No. Ni	D (mm)	L (mm)	Ø (mm)	Ø (mm)	SW (mm)	TL (mm)	
EMSKE 12 EMV-Z	10065056	M 12x1,5	5	4 - 7	5	16	23 - 30	50
EMSKE 16 EMV-Z	10065057	M 16x1,5	5	4,5 - 10	7,5	20	26 - 34	50
EMSKE 20 EMV-Z	10065058	M 20x1,5	6	6 - 13	9,5	24	29 - 37	50
EMSKE 25 EMV-Z	10065059	M 25x1,5	7	10 - 17	16	29	33 - 42	50
EMSKE 32 EMV-Z	10065060	M 32x1,5	8	13 - 21	20	36	36 - 44	25
EMSKE 40 EMV-Z	10065061	M 40x1,5	8	16 - 28	26	46	44 - 55	10
EMSKE 50 EMV-Z	10065062	M 50x1,5	9	21 - 35	33	55	51 - 62	10
EMSKE 63 EMV-Z	10065063	M 63x1,5	10	34 - 48	45	68	56 - 67	10
EMSKE 75 EMV-Z	10104143	M75X1,5	10	48 - 62		82	67 - 81	1

EMSKE-L EMV-Z, lang

Type	WISKA-No. Ni	D (mm)	L (mm)	Ø (mm)	Ø (mm)	SW (mm)	TL (mm)	
EMSKE-L 12 EMV-Z	10065922	M 12x1,5	12	4 - 7	5	16	30 - 37	50
EMSKE-L 16 EMV-Z	10065923	M 16x1,5	12	5 - 10	7,5	20	33 - 41	50
EMSKE-L 20 EMV-Z	10065924	M 20x1,5	12	6 - 13	9,5	24	35 - 43	50
EMSKE-L 25 EMV-Z	10065925	M 25x1,5	12	10 - 17	16	29	38 - 47	50
EMSKE-L 32 EMV-Z	10065927	M 32x1,5	15	13 - 21	20	36	43 - 51	25
EMSKE-L 40 EMV-Z	10065927	M 40x1,5	15	16 - 28	26	46	51 - 62	10
EMSKE-L 50 EMV-Z	10065928	M 50x1,5	15	21 - 35	33	55	57 - 68	10
EMSKE-L 63 EMV-Z	10065929	M 63x1,5	15	34 - 48	45	68	61 - 72	10

Empfohlenes Zubehör



RDE

EMMU-EMV

BS



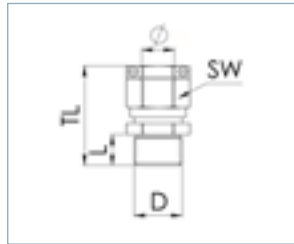

SPRINT EX Kabelverschraubungen mit externer Zugentlastung, EMSKEZ, Messing vernickelt, metrisch



EMSKEZ



Kennzeichnung II 2 D Ex tb IIIC Db IP68 / II 2 G Ex e IIC Gb
Bescheinigung IECEx PTB 13.0052 / PTB 09 ATEX 1049
Schutzart IP68 (5 bar 30 min)
Einsatztemperatur -40 °C - 75 °C
Material Verschraubung Messing vernickelt, Klemmkäfig Polyamid, Dichtung EPDM

Type	WISKA-No. Ni	 D [mm]	 [mm]	 [mm]	 SW [mm]	TL [mm]	
EMSKEZ 16	10063071	M 16x1,5	5	6,5 · 10	20	36 · 44	25
EMSKEZ 20	10063072	M 20x1,5	6	8 · 13	24	39 · 47	25
EMSKEZ 25	10063073	M 25x1,5	7	10 · 17	29	43 · 52	25
EMSKEZ 32	10063074	M 32x1,5	8	16 · 21	36	46 · 54	25
EMSKEZ 40	10063075	M 40x1,5	8	18 · 28	46	54 · 65	10
EMSKEZ 50	10063076	M 50x1,5	9	22 · 35	55	61 · 72	10
EMSKEZ 63	10063077	M 63x1,5	10	35 · 48	68	66 · 77	10

Empfohlenes Zubehör

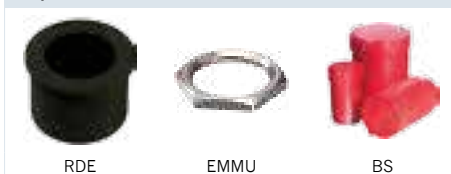

RDE

EMMU

BS





EX Verschlusschrauben, EX-EMVS, Messing vernickelt, metrisch

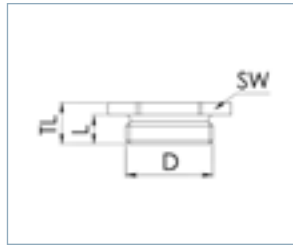

EX-EMVS



Kennzeichnung II 2 D Ex tb IIIC Db / II 2 G Ex e IIC Gb
Bescheinigung IECEx PTB 14.0024 / PTB 05 ATEX 1106
Schutzart IP66 / IP68 (5 bar 30 min)
Einsatztemperatur -40 °C - 120 °C
Material Messing vernickelt, Dichtung EPDM

Type	WISKA-No. Ni	 D (mm)	 L (mm)	 SW (mm)	TL (mm)	
EX-EMVS 12	10065331	M 12x1,5	5	14	7,5	10
EX-EMVS 16	10065332	M 16x1,5	5	18	8	10
EX-EMVS 20	10065333	M 20x1,5	6	22	9	10
EX-EMVS 25	10065334	M 25x1,5	6,5	28	10	10
EX-EMVS 32	10065335	M 32x1,5	7	35	10,5	5
EX-EMVS 40	10065336	M 40x1,5	8	44	12	5
EX-EMVS 50	10065337	M 50x1,5	9	54	15	1
EX-EMVS 63	10065338	M 63x1,5	10	67	16	1

Empfohlenes Zubehör



EMMU

KABEL-
VER-
SCHRAU-
BUNGENKUNST-
STOFF

METALL

MARITIM

EMV

EX E/I

EX D

RAILWAY

BRÜCKEN-
GLEICH /
VENTINGBRITISH
STANDARDDICHT-
TUNGENMEMBRAN-
EINFÜH-
RUNGEN

MEMBRAN

KABEL-
EINFÜH-
RUNGS-
SYSTEM

CONMAXX

CONMAXX
TEILB. VER-
SCHRAU-
BUNGKABEL-
SCHUTZBRACE
FITTING
KUNST-
STOFFBRACE
CONDUIT
KUNST-
STOFFBRACE
FITTING
METALLBRACE
CONDUIT
METALLBRACE
SLEEVE

SPRINT EX Kabelverschraubungen, ESSKE, Edelstahl, metrisch



ESSKE



ESSKE-4

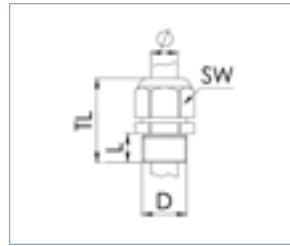

Kennzeichnung II 2 D Ex tb IIIC Db / II 2 G Ex eb IIC Gb
Bescheinigung IECEx PTB 13.0035X / PTB 05 ATEX 1098 X
Schutzart IP66 / IP68 (5 bar 30 min)
Einsatztemperatur -40 °C - 75 °C
Material Verschraubung Edelstahl, Klemmkäfig Polyamid, Dichtung EPDM

ESSKE, Edelstahl 1.4305

Type	WISKA-No.					TL (mm)	
ESSKE 12	10069200	M 12x1,5	5	4 · 7	17	23 · 30	10
ESSKE 16	10069201	M 16x1,5	5	5 · 10	22	26 · 34	10
ESSKE 20	10069202	M 20x1,5	6	6 · 13	24	29 · 37	10
ESSKE 25	10069203	M 25x1,5	7	10 · 17	30	33 · 42	10
ESSKE 32	10069204	M 32x1,5	8	13 · 21	36	36 · 44	5
ESSKE 40	10069205	M 40x1,5	8	16 · 28	46	44 · 55	5
ESSKE 50	10069206	M 50x1,5	9	21 · 35	55	51 · 62	2
ESSKE 63	10069207	M 63x1,5	10	34 · 48	68	56 · 67	1

ESSKE-4, Edelstahl 1.4404

Type	WISKA-No.					TL (mm)	
ESSKE-4 12	10069232	M 12x1,5	5	4 · 7	17	23 · 30	10
ESSKE-4 16	10069233	M 16x1,5	5	5 · 10	22	26 · 34	10
ESSKE-4 20	10069234	M 20x1,5	6	6 · 13	24	29 · 37	10
ESSKE-4 25	10069235	M 25x1,5	7	10 · 17	30	33 · 42	10
ESSKE-4 32	10069236	M 32x1,5	8	13 · 21	36	36 · 44	5
ESSKE-4 40	10069237	M 40x1,5	8	16 · 28	46	44 · 55	5
ESSKE-4 50	10069238	M 50x1,5	9	21 · 35	55	51 · 62	2
ESSKE-4 63	10069239	M 63x1,5	10	34 · 48	68	56 · 67	1

Empfohlenes Zubehör



RDE

BS

ESMU

MFD RW

SPRINT EX EMV Kabelverschraubungen mit Erdungseinsatz DIN 89345, ESSKE EMV-Z, Edelstahl, metrisch

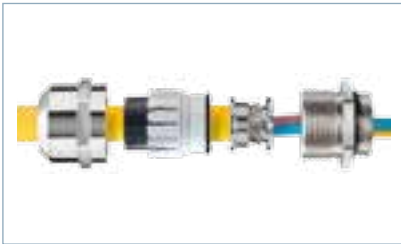

ESSKE EMV-Z

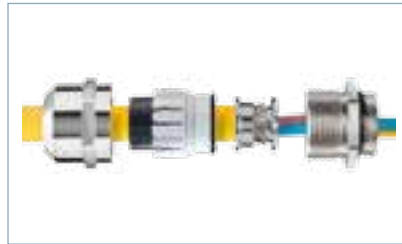

ESSKE-4 EMV-Z

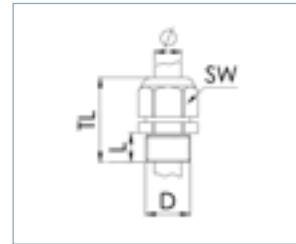

Kennzeichnung	II 2 D Ex tb IIIC Db / II 2 G Ex eb IIC Gb
Bescheinigung	IECEx PTB 13.0035X / PTB 05 ATEX 1098 X
Schutzart	IP66 / IP68 (5 bar 30 min)
Einsatztemperatur	-40 °C - 75 °C
Material	Verschraubung Edelstahl, Klemmkäfig Polyamid, Dichtung EPDM, Erdungseinsatz Messing verchromt

ESSKE EMV-Z, Edelstahl 1.4305

Type	WISKA-No.	D (mm)	L (mm)	Ø (mm)	Ø (mm)	SW (mm)	TL (mm)	
ESSKE 12 EMV-Z	10069216	M 12x1,5	5	4 - 7	5	17	23 - 30	10
ESSKE 16 EMV-Z	10069217	M 16x1,5	5	5 - 10	7,5	22	26 - 34	10
ESSKE 20 EMV-Z	10069218	M 20x1,5	6	6 - 13	9,5	24	29 - 37	10
ESSKE 25 EMV-Z	10069219	M 25x1,5	7	10 - 17	16	30	33 - 42	10
ESSKE 32 EMV-Z	10069220	M 32x1,5	8	13 - 21	20	36	36 - 44	5
ESSKE 40 EMV-Z	10069221	M 40x1,5	8	16 - 28	26	46	44 - 55	5
ESSKE 50 EMV-Z	10069222	M 50x1,5	9	21 - 35	33	55	51 - 62	2
ESSKE 63 EMV-Z	10069223	M 63x1,5	10	34 - 48	45	68	56 - 67	1

ESSKE-4 EMV-Z, Edelstahl 1.4404

Type	WISKA-No.	D (mm)	L (mm)	Ø (mm)	Ø (mm)	SW (mm)	TL (mm)	
ESSKE-4 12 EMV-Z	10069248	M 12x1,5	5	4 - 7	5	17	23 - 30	10
ESSKE-4 16 EMV-Z	10069249	M 16x1,5	5	5 - 10	7,5	22	26 - 34	10
ESSKE-4 20 EMV-Z	10069250	M 20x1,5	6	6 - 13	9,5	24	29 - 37	10
ESSKE-4 25 EMV-Z	10069251	M 25x1,5	7	10 - 17	16	30	33 - 42	10
ESSKE-4 32 EMV-Z	10069252	M 32x1,5	8	13 - 21	20	36	36 - 44	5
ESSKE-4 40 EMV-Z	10069253	M 40x1,5	8	16 - 28	26	46	44 - 55	5
ESSKE-4 50 EMV-Z	10069254	M 50x1,5	9	21 - 35	33	55	51 - 62	2
ESSKE-4 63 EMV-Z	10069255	M 63x1,5	10	34 - 48	45	68	56 - 67	1

Empfohlenes Zubehör



RDE

BS

ESMU

KABEL-VER-SCHRAUBUNGEN
 KUNST-STOFF
 METALL
 MARTIM
 EMV
 EX E/I
 EX D
 RAILWAY
 DRUCKAUS-GLEICH / VENTING
 BRITISH STANDARD
 DICH-TUNGEN
 MEMBRAN-EINFÜHRUNGEN
 KABEL-EINFÜHRUNGS-SYSTEM
 CONMAXX
 CONMAXX TEILB. VER-SCHRAUBUNG
 KABEL-SCHUTZ
 BRACE FITTING KUNST-STOFF
 BRACE FITTING KUNST-STOFF
 BRACE FITTING METALL
 BRACE CONDUIT METALL
 BRACE SLEEVE

EX d Kabelverschraubungen für ungeschirmte Kabel, OSNJ, Messing vernickelt, metrisch

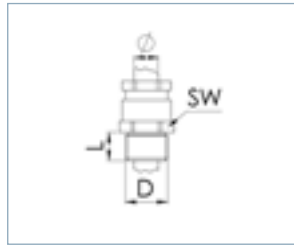

OSNJ

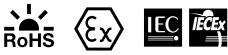

Kennzeichnung Ex d IIC / Ex e IICEx tD A21 IP66/IP67
Bescheinigung IECEx KOS 09.0017X / NEMKO 03 ATEX 1460 X
Schutzart IP67
Einsatztemperatur -20 °C - 120 °C
Material Verschraubung: Messing vernickelt, Dichtung Silikon

Type	WISKA-No. Ni						
OSNJ A2F-16a	50065500	M 16x1,5	15	3 - 7,5	19	24	1
OSNJ A2F-16b	50065501	M 16x1,5	15	6,1 - 10	19	24	1
OSNJ A2F-20a	50065502	M 20x1,5	15	10 - 13	24	27	1
OSNJ A2F-20b	50065503	M 20x1,5	15	13,1 - 15	24	27	1
OSNJ A2F-25a	50065504	M 25x1,5	15	14 - 17,5	28	32	1
OSNJ A2F-25b	50065505	M 25x1,5	15	16,1 - 19,5	28	32	1
OSNJ A2F-32a	50065506	M 32x1,5	15	18,1 - 22	34	39	1
OSNJ A2F-32b	50065507	M 32x1,5	15	21 - 26	34	39	1
OSNJ A2F-40a	50065508	M 40x1,5	15	24 - 28	42	48	1
OSNJ A2F-40b	50065509	M 40x1,5	15	27 - 32	42	48	1
OSNJ A2F-50a	50065510	M 50x1,5	15	32,1 - 34	53	58	1
OSNJ A2F-50b	50065511	M 50x1,5	15	34,1 - 40	53	58	1
OSNJ A2F-63a	50065512	M 63x1,5	15	38 - 44	65	73	1
OSNJ A2F-63b	50065513	M 63x1,5	15	43 - 50	65	73	1
OSNJ A2F-63c	50065514	M 63x1,5	15	49 - 54	65	73	1
OSNJ A2F-75a	50065515	M 75x1,5	15	52 - 56	78	85	1
OSNJ A2F-75b	50065516	M 75x1,5	15	55 - 60	78	85	1
OSNJ A2F-75c	50065517	M 75x1,5	15	59 - 62	78	85	1
OSNJ A2F-75d	50065518	M 75x1,5	15	62,1 - 66	78	85	1





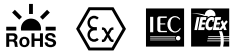
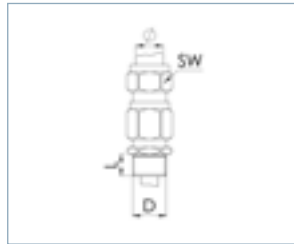

EX d Kabelverschraubungen für Kabel mit Geflecht-/Stahlbandschirmung, WEID.E1XF, Messing vernickelt, metrisch



WEID.E1XF



Kennzeichnung Ex d IIC / Ex e IICx tD A21 IP66/IP67
Bescheinigung IECEx KOS 09.0016X / NEMKO 02 ATEX 501 X
Schutzart IP67
Einsatztemperatur -20 °C · 120 °C
Material Verschraubung Messing vernickelt, Dichtung Silikon

Type	WISKA-No. Ni	 D [mm]	 L [mm]	 G [mm]	 H [mm]	 SW [mm]	 B [mm]
WEID.E1XF-16a	50065574	M 16x1,5	15	8 · 13	5 · 11	25	1
WEID.E1XF-16b	50103247	M 16x1,5	15	12 · 15,1	5 · 11	25	1
WEID.E1XF-20a	50065575	M 20x1,5	15	13 · 17,5	8 · 15,5	31	1
WEID.E1XF-20b	50065576	M 20x1,5	15	17,5 · 22	8 · 15,1	31	1
WEID.E1XF-25a	50065577	M 25x1,5	15	17,5 · 22	13 · 19,5	36	1
WEID.E1XF-25b	50065578	M 25x1,5	15	21 · 26	13 · 19,5	36	1
WEID.E1XF-32a	50065579	M 32x1,5	15	22 · 28	17,5 · 26	45	1
WEID.E1XF-32b	50065580	M 32x1,5	15	27 · 32	17,5 · 26	45	1
WEID.E1XF-40a	50065581	M 40x1,5	15	30 · 35	22 · 32	55	1
WEID.E1XF-40b	50065582	M 40x1,5	15	35,1 · 40	22 · 32	55	1
WEID.E1XF-50a	50065583	M 50x1,5	15	38 · 45	30 · 41,5	68	1
WEID.E1XF-50b	50065584	M 50x1,5	15	43 · 50	30 · 41,5	68	1
WEID.E1XF-63a	50065585	M 63x1,5	15	48 · 53	38 · 54	82	1
WEID.E1XF-63b	50065586	M 63x1,5	15	51 · 56	38 · 54	82	1
WEID.E1XF-63c	50065587	M 63x1,5	15	55 · 60	38 · 54	82	1
WEID.E1XF-75a	50065588	M 75x1,5	20	56 · 62	49 · 66	98	1
WEID.E1XF-75b	50065589	M 75x1,5	20	62,1 · 66	49 · 66	98	1
WEID.E1XF-75c	50065590	M 75x1,5	20	66,1 · 70	49 · 66	98	1
WEID.E1XF-75d	50065591	M 75x1,5	20	68 · 75	49 · 66	98	1

KABEL-VER-SCHRAUBUNGEN
KUNST-STOFF
METALL
MARTITIM
EMV
EX E/I
EX D
RAILWAY
DRUCKAUS-GLEICH / VENTING
BRITISH STANDARD
DICH-TUNGEN
MEMBRAN-EINFÜH-RUNGEN
MEMBRAN
KABEL-EINFÜH-RUNGS-SYSTEM
CONMAXX
CONMAXX-TEILB-VER-SCHRAU-BUNG
KABEL-SCHUTZ
BRACE FITTING KUNST-STOFF
BRACE CONDUIT KUNST-STOFF
BRACE FITTING METALL
BRACE CONDUIT METALL
BRACE SLEEVE

EX d Kabelverschraubungen für geschirmte Kabel, WEID.E1WF, Einzeladerschirmung, Messing vernickelt, metrisch

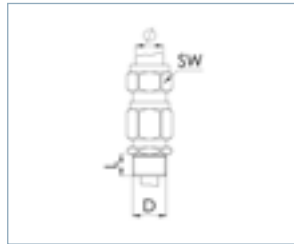

WEID.E1WF



Kennzeichnung Ex d IIC / Ex e IICx tD A21 IP66/IP67
Bescheinigung IECEx KOS 09.0018X / NEMKO 02 ATEX 500 X
Schutzart IP67
Einsatztemperatur -20 °C · 120 °C
Material Verschraubung Messing vernickelt, Dichtung Silikon

Type	WISKA-No. Ni						
WEID.E1WF-16a	50065537	M 16x1,5	15	8 · 13	5 · 11	25	1
WEID.E1WF-16b	50065538	M 16x1,5	15	12 · 15,1	5 · 11	25	1
WEID.E1WF-20a	50065539	M 20x1,5	15	13 · 17,5	8 · 15,5	31	1
WEID.E1WF-20b	50065540	M 20x1,5	15	16 · 19,5	8 · 15,1	31	1
WEID.E1WF-25a	50065541	M 25x1,5	15	17,5 · 22	13 · 19,5	36	1
WEID.E1WF-25b	50065542	M 25x1,5	15	21 · 26	13 · 19,5	36	1
WEID.E1WF-32a	50065543	M 32x1,5	15	22 · 28	17,5 · 26	45	1
WEID.E1WF-32b	50065544	M 32x1,5	15	27 · 32	17,5 · 26	45	1
WEID.E1WF-40a	50065545	M 40x1,5	15	30 · 35	22 · 32	55	1
WEID.E1WF-40b	50065546	M 40x1,5	15	35,1 · 40	22 · 32	55	1
WEID.E1WF-50a	50065547	M 50x1,5	15	38 · 45	30 · 41,5	68	1
WEID.E1WF-50b	50065548	M 50x1,5	15	43 · 50	30 · 41,5	68	1
WEID.E1WF-63a	50065549	M 63x1,5	15	48 · 53	38 · 54	82	1
WEID.E1WF-63b	50065550	M 63x1,5	15	51 · 56	38 · 54	82	1
WEID.E1WF-63c	50065551	M 63x1,5	15	55 · 60	38 · 54	82	1
WEID.E1WF-75a	50065552	M 75x1,5	20	56 · 62	49 · 66	98	1
WEID.E1WF-75b	50065553	M 75x1,5	20	62,1 · 66	49 · 66	98	1
WEID.E1WF-75c	50065554	M 75x1,5	20	66,1 · 70	49 · 66	98	1
WEID.E1WF-75d	50065555	M 75x1,5	20	68 · 75	49 · 66	98	1

EX d Verschlusschrauben, OSSP, Messing vernickelt, metrisch



OSSP

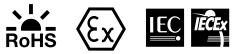
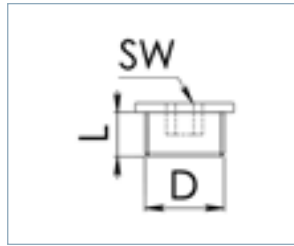

Kennzeichnung Ex d IIC / Ex e IICx tD A21 IP66/IP67
Bescheinigung IECEx KOS 09.0005X / NEMKO 02 ATEX 502
Schutzart IP67
Einsatztemperatur -20 °C - 120 °C
Material Messing vernickelt, Dichtung CR

Type	WISKA-No. Ni				
OSSP-R 16	50065610	M 16x1,5	15	10	1
OSSP-R 20	50065611	M 20x1,5	15	10	1
OSSP-R 25	50065612	M 25x1,5	15	10	1
OSSP-R 32	50065613	M 32x1,5	15	10	1
OSSP-R 40	50065614	M 40x1,5	15	10	1
OSSP-R 50	50065615	M 50x1,5	15	10	1
OSSP-R 63	50065616	M 63x1,5	15	10	1
OSSP-R 75	50065617	M 75x1,5	15	10	1

KABEL-VER-SCHRAUBUNGEN
KUNST-STOFF
METALL
MARTIM
EMV
EX E/I
EX D
RAILWAY
BRÜCKEN-DRUCKHAUS-GLEICH / VENTING
BRITISH STANDARD
DÜBEL- / TUNGEN
MEMBRAN-EINFÜHRUNGEN
MEMBRAN
KABEL-EINFÜHRUNGSSYSTEM
CONMAXX
CONMAXX TEILB. VER-SCHRAUBUNG
KABEL-SCHUTZ
BRACE FITTING KUNST-STOFF
BRACE CONDUIT KUNST-STOFF
BRACE FITTING METALL
BRACE CONDUIT METALL
BRACE SLEEVE

EX d Reduzierungen, OSRA, Messing vernickelt, metrisch-metrisch

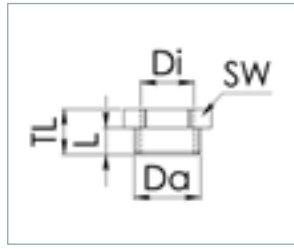

OSRA



Kennzeichnung
Bescheinigung
Schutzart
Material

Ex d IIC / Ex e IIC tD A21 IP66/IP67
IECEX KOS 09.0003X / NEMKO 03 ATEX 1458 X
IP67
Messing vernickelt

Type	WISKA-No. Ni	Da (mm)	Di (mm)	SW (mm)	
OSRA 20-16	50065650	M 20x1,5	M 16x1,5	25	1
OSRA 25-16	50065651	M 25x1,5	M 16x1,5	30	1
OSRA 25-20	50065652	M 25x1,5	M 20x1,5	30	1
OSRA 32-16	50065653	M 32x1,5	M 16x1,5	38	1
OSRA 32-20	50065654	M 32x1,5	M 20x1,5	38	1
OSRA 32-25	50065655	M 32x1,5	M 25x1,5	38	1
OSRA 40-20	50065656	M 40x1,5	M 20x1,5	45	1
OSRA 40-25	50065657	M 40x1,5	M 25x1,5	45	1
OSRA 40-32	50065658	M 40x1,5	M 32x1,5	45	1
OSRA 50-25	50065659	M 50x1,5	M 25x1,5	55	1
OSRA 50-32	50065660	M 50x1,5	M 32x1,5	55	1
OSRA 50-40	50065661	M 50x1,5	M 40x1,5	55	1
OSRA 63-32	50065662	M 63x1,5	M 32x1,5	68	1
OSRA 63-40	50065663	M 63x1,5	M 40x1,5	68	1
OSRA 63-50	50065664	M 63x1,5	M 50x1,5	68	1
OSRA 75-40	50065665	M 75x1,5	M 40x1,5	82	1
OSRA 75-50	50065666	M 75x1,5	M 50x1,5	82	1
OSRA 75-63	50065667	M 75x1,5	M 63x1,5	82	1

EX d Erweiterungen, OSAJ, Messing vernickelt, metrisch-metrisch

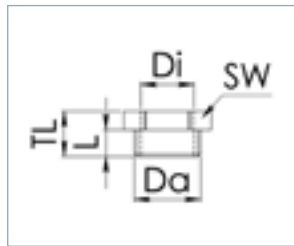

OSAJ



Kennzeichnung
Bescheinigung
Schutzart
Material

Ex d IIC / Ex e IIC tD A21 IP66/IP67
IECEX KOS 09.0002X / NEMKO 03 ATEX 1459 X
IP67
Messing vernickelt

Type	WISKA-No. Ni	Da (mm)	Di (mm)	SW (mm)	
OSAJ 16/20	50065686	M 16x1,5	M 20x1,5	25	1
OSAJ 16/25	50065687	M 16x1,5	M 25x1,5	30	1
OSAJ 20/25	50065688	M 20x1,5	M 25x1,5	30	1
OSAJ 16/32	50065689	M 16x1,5	M 32x1,5	37	1
OSAJ 20/32	50065690	M 20x1,5	M 32x1,5	37	1
OSAJ 25/32	50065691	M 25x1,5	M 32x1,5	37	1
OSAJ 20/40	50065692	M 20x1,5	M 40x1,5	46	1
OSAJ 25/40	50065693	M 25x1,5	M 40x1,5	46	1
OSAJ 32/40	50065694	M 32x1,5	M 40x1,5	46	1
OSAJ 25/50	50065695	M 25x1,5	M 50x1,5	57	1
OSAJ 32/50	50065696	M 32x1,5	M 50x1,5	57	1
OSAJ 40/50	50065697	M 40x1,5	M 50x1,5	57	1
OSAJ 32/63	50065698	M 32x1,5	M 63x1,5	70	1
OSAJ 40/63	50065699	M 40x1,5	M 63x1,5	70	1
OSAJ 50/63	50065700	M 50x1,5	M 63x1,5	70	1
OSAJ 40/75	50065701	M 40x1,5	M 75x1,5	82	1
OSAJ 50/75	50065702	M 50x1,5	M 75x1,5	82	1
OSAJ 63/75	50065703	M 63x1,5	M 75x1,5	82	1

Erdanschlussslaschen, OSET, Messing



OSET



Material

Messing vernickelt

Type	WISKA-No. Ni		
OSET 16	50065634	M 16	1
OSET 20	50065635	M 20	1
OSET 25	50065636	M 25	1
OSET 32	50065637	M 32	1
OSET 40	50065638	M 40	1
OSET 50	50065639	M 50	1
OSET 63	50065640	M 63	1
OSET 75	50065641	M 75	1

KABEL-
VER-
SCHRAU-
BUNGEN

KUNST-
STOFF

METALL

MARTITIM

ENV

EX E/I

EX D

RAILWAY

DRUCKAUS-
GLEICH /
VENTING

BRITISH
STANDARD

DICH-
TUNGEN

MEMBRAN-
EINFÜH-
RUNGEN

MEMBRAN

KABEL-
EINFÜH-
RUNGS-
SYSTEM

CONMAXX

CONMAXX
TEILB. VER-
SCHRAU-
BUNG

KABEL-
SCHUTZ

BRACE
FITTING
KUNST-
STOFF

BRACE
CONDUIT
KUNST-
STOFF

BRACE
FITTING
METALL

BRACE
CONDUIT
METALL

BRACE
SLEEVE

Schutztüllen, OSSH, Kunststoff





OSSH





Material EPDM

OSSH (A), Typ A

Type	WISKA-No.		
OSSH-A16	50065626	E1XF / W 16	1
OSSH-A20	50065627	E1XF / W 20	1
OSSH-A25	50065628	E1XF / W 25	1
OSSH-A32	50065629	E1XF / W 32	1
OSSH-A40	50065630	E1XF / W 40	1
OSSH-A50	50065631	E1XF / W 50	1
OSSH-A63	50065632	E1XF / W 63	1
OSSH-A75	50065633	E1XF / W 75	1

OSSH (B), Typ B

Type	WISKA-No.		
OSSH-B16	50065642	A2F16	1
OSSH-B20	50065643	A2F20	1
OSSH-B25	50065644	A2F25	1
OSSH-B32	50065645	A2F32	1
OSSH-B40	50065646	A2F40	1
OSSH-B50	50065647	A2F50	1
OSSH-B63	50065648	A2F63	1
OSSH-B75	50065649	A2F75	1



Railway Kabelverschraubungen

Speziell für die Bahnindustrie bieten wir Ihnen unsere eigene Serie aus Railway-Kabelverschraubungen. Sie entsprechen den hohen Qualitäts- und Sicherheitsanforderungen der europäischen Brandschutznorm EN 45545 und erreichen die höchste Gefährdungsstufe Hazard Level 3. Unsere Kabelverschraubungen aus Kunststoff, Messing oder Edelstahl sind darüber hinaus modular mit ihrem Zubehör einsetzbar.



Für die Schiene gemacht

Unsere Railway-Serie ist eine branchenspezifische Erweiterung des bewährten Kabelverschraubungssystems SPRINT, das die besonderen Ansprüche der Bahnindustrie in allen Belangen erfüllt.

Seit Juni 2013 müssen Produkte und Werkstoffe, die im Schienenverkehr zum Einsatz kommen, nach der vereinheitlichten europäischen Brandschutznorm EN 45545 geprüft werden. Daher haben wir dank mehrjähriger Forschungs- und Entwicklungsarbeit eine innovative Produktserie auf den Markt gebracht, die alle geforderten Qualitäts- und Sicherheitsstandards erfüllt und die höchste Gefährdungsstufe Hazard Level 3 erreicht.

Zudem sind wir einer der ersten europäischen Hersteller, der eine komplette Verschraubungsserie in den Materialien Messing, Polyamid und Edelstahl nach EN 45545 erfolgreich geprüft hat. Damit sind unsere Railway-Kabelverschraubungen die ideale Kombination aus hochwertigster Produktqualität und vielfacher Modularität bei gleichzeitiger Normeinhaltung. Sie können von Herstellern, Zulieferern und Bahntechnikunternehmen uneingeschränkt in allen Fahrzeugtypen – egal ob Neufahrzeuge oder zur Instandsetzung – eingesetzt werden.

Innovativster Materialeinsatz

Im Rahmen der umfangreichen Materialprüfung haben wir das Brandverhalten von Werk- und Rohstoffen gemäß EN 45545-2 getestet. Dabei haben wir unterschiedlichste Materialien erprobt, um eine optimale Zusammensetzung für die Railway-Serie zu erreichen.

Für die Anforderungssätze R22 (Inneneinsatz) und R23 (Außeneinsatz) werden folgende Parameter von den brennbaren Materialien (Kunststoff, Dichtungsmaterial) abgeprüft:

Anforderungssatz	Parameter	Einheit	Anforderung	HL1	HL2	HL3
R22	Sauerstoff-Index	Vol.-%	Minimum	28	28	32
	Rauchgasdichte	D _s max.	Maximum	600	300	150
	Toxizität	CIT _{NLP}	Maximum	1,2	0,9	0,75
R23	Sauerstoff-Index	Vol.-%	Minimum	28	28	32
	Rauchgasdichte	D _s max.	Maximum	---	600	300
	Toxizität	CIT _{NLP}	Maximum	---	1,8	1,5

SPRINT Railway Kabelverschraubungen, ESKV RW, Kunststoff, metrisch, EN 45545



ESKV RW

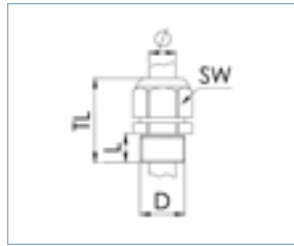

Schutzart IP68 (5 bar 30 min) / IP69
Einsatztemperatur -40 °C · 100 °C
Hazard level EN gem. 45545 R22=HL3 / R23=HL3
Material Verschraubung Polyamid UL94-V0, Dichtung EPDM

Type	WISKA-No. RAL 7035 LG	WISKA-No. RAL 7001 SG	WISKA-No. RAL 9005 BK					TL (mm)	
ESKV 12 RW	10105492	10105802	10105810	M 12x1,5	9	3 · 7	16	29 · 34	50
ESKV 16 RW	10105493	10105803	10105811	M 16x1,5	9	4,5 · 10	20	31 · 37	50
ESKV 20 RW	10105494	10105804	10105812	M 20x1,5	10	6 · 13	24	36 · 45	50
ESKV 25 RW	10105495	10105805	10105813	M 25x1,5	10	9 · 17	29	38 · 47	50
ESKV 32 RW	10105496	10105806	10105814	M 32x1,5	12	13 · 21	36	42 · 51	25
ESKV 40 RW	10105497	10105807	10105815	M 40x1,5	12	16 · 28	46	52 · 65	10
ESKV 50 RW	10105498	10105808	10105816	M 50x1,5	14	21 · 35	55	59 · 72	4
ESKV 63 RW	10105499	10105809	10105817	M 63x1,5	15	34 · 48	68	64 · 78	3

Empfohlenes Zubehör



EMUF

EADR

BS

RDE RW

MFD RW

KABEL-
VER-
SCHRAU-
BUNGEN

KUNST-
STOFF

METALL

MARTIM

ENV

EX E/I

EX D

RAILWAY

BRUCKAUS-
GLEICH /
VENTING

BRITISH
STANDARD

DICH-
TUNGEN

MEMBRAN-
EINFÜH-
RUNGEN

KABEL-
EINFÜH-
RUNGS-
SYSTEM

CONMAXX

CONMAXX
TEILB. VER-
SCHRAU-
BUNG

KABEL-
SCHUTZ

BRACE
FITTING
KUNST-
STOFF

BRACE
CONDUIT
KUNST-
STOFF

BRACE
FITTING
METALL

BRACE
CONDUIT
METALL

BRACE
SLEEVE

SPRINT Railway Kabelverschraubungen, EMSKV RW, Messing vernickelt, metrisch, EN 45545



EMSKV RW



EMSKV-L RW

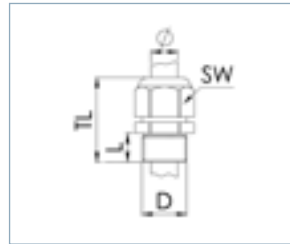

Schutzart IP68 (5 bar 30 min) / IP69
Einsatztemperatur -40 °C · 100 °C
Hazard level EN gem. 45545 R22=HL3 / R23=HL3
Material Verschraubung Messing vernickelt, Klemmkäfig Polyamid UL94-V0, Dichtung EPDM

EMSKV RW

Type	WISKA-No. Ni	D (mm)	L (mm)	Ø (mm)	SW (mm)	TL (mm)	Box
EMSKV 12 RW	10104293	M 12x1,5	5	3 · 7	16	23 · 30	50
EMSKV 16 RW	10104294	M 16x1,5	5	4,5 · 10	20	26 · 34	50
EMSKV 20 RW	10104296	M 20x1,5	6	6 · 13	24	29 · 37	50
EMSKV 25 RW	10104297	M 25x1,5	7	9 · 17	29	33 · 42	50
EMSKV 32 RW	10104298	M 32x1,5	8	13 · 21	36	36 · 44	25
EMSKV 40 RW	10104299	M 40x1,5	8	16 · 28	46	44 · 55	10
EMSKV 50 RW	10104300	M 50x1,5	9	21 · 35	55	51 · 62	10
EMSKV 63 RW	10104301	M 63x1,5	10	34 · 48	68	56 · 67	10
EMSKV 75 RW	10104302	M 75x1,5	12	48 · 62	82	67 · 81	1

EMSKV-L RW, lang

Type	WISKA-No. Ni	D (mm)	L (mm)	Ø (mm)	SW (mm)	TL (mm)	Box
EMSKV-L 12 RW	10106174	M 12x1,5	12	3 · 7	16	30 · 37	50
EMSKV-L 16 RW	10106175	M 16x1,5	12	4,5 · 10	20	33 · 41	50
EMSKV-L 20 RW	10106176	M 20x1,5	12	6 · 13	24	35 · 43	50
EMSKV-L 25 RW	10106177	M 25x1,5	12	9 · 17	29	38 · 47	50
EMSKV-L 32 RW	10106178	M 32x1,5	15	13 · 21	36	43 · 51	25
EMSKV-L 40 RW	10106179	M 40x1,5	15	16 · 28	46	51 · 62	10
EMSKV-L 50 RW	10106180	M 50x1,5	15	21 · 35	55	57 · 68	10
EMSKV-L 63 RW	10106181	M 63x1,5	15	34 · 48	68	61 · 72	10

Empfohlenes Zubehör



EADR

EMMU

BS

RDE RW

MFD RW

SPRINT Railway Kabelverschraubungen LowTemp, EMSKV LT RW, Messing vernickelt, metrisch, EN 45545



EMSKV LT RW

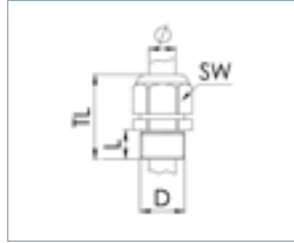

Schutzart

Einsatztemperatur

Hazard level EN gem. 45545





Material

IP68 (5 bar 30 min) / IP69

-60 °C · 100 °C

R22=HL1 / R23=HL2

Verschraubung Messing vernickelt, Klemmkäfig Polyamid UL94-V0, Dichtung Silikon

Type	WISKA-No. Ni					TL (mm)	
EMSKV 12 LT RW	10105823	M 12x1,5	5	3 - 7	16	23 - 30	50
EMSKV 16 LT RW	10105824	M 16x1,5	5	4,5 - 10	20	26 - 34	50
EMSKV 20 LT RW	10105825	M 20x1,5	6	6 - 13	24	29 - 37	50
EMSKV 25 LT RW	10105826	M 25x1,5	7	9 - 17	29	33 - 42	50
EMSKV 32 LT RW	10105827	M 32x1,5	8	13 - 21	36	36 - 44	25
EMSKV 40 LT RW	10105828	M 40x1,5	8	16 - 28	46	44 - 55	10
EMSKV 50 LT RW	10105829	M 50x1,5	9	21 - 35	55	51 - 62	10
EMSKV 63 LT RW	10105830	M 63x1,5	10	34 - 48	68	56 - 67	10

Empfohlenes Zubehör



EMMU

RDE LT

BS

ORD-S

KABEL-VER-SCHRAUBUNGEN
KUNST-STOFF
METALL
MARTIM
ENV
EX E/I
EX D
RAILWAY
DRUCKAUS-GLEICH / VENTING
BRITISH STANDARD
DICH-TUNGEN
MEMBRAN-EINFÜHRUNGEN
MEMBRAN
KABEL-EINFÜHRUNGS-SYSTEM
CONMAXX
CONMAXX-TEILB-VER-SCHRAUBUNG
KABEL-SCHUTZ
BRACE FITTING KUNST-STOFF
BRACE CONDUIT KUNST-STOFF
BRACE FITTING METALL
BRACE CONDUIT METALL
BRACE SLEEVE

SPRINT EMV Railway Kabelverschraubungen mit Erdungseinsatz DIN 89345,
EMSKV EMV-Z RW, Messing vernickelt, metrisch, EN 45545

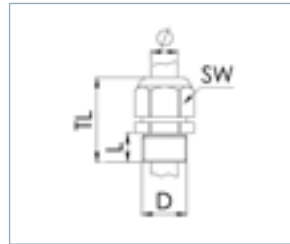

EMSKV EMV-Z RW



Schutzart IP68 (5 bar 30 min) / IP69
Einsatztemperatur -40 °C · 100 °C
Hazard level EN gem. 45545 R22=HL3 / R23=HL3
Material Verschraubung Messing vernickelt, Klemmkäfig Polyamid UL94-V0,
 Erdungseinsatz Messing verchromt, Dichtung EPDM

Type	WISKA-No. Ni					TL (mm)	
EMSKV 12 EMV-Z RW	10104303	M 12x1,5	5	3 · 7	16	23 · 30	50
EMSKV 16 EMV-Z RW	10104304	M 16x1,5	5	4,5 · 10	20	26 · 34	50
EMSKV 20 EMV-Z RW	10104305	M 20x1,5	6	6 · 13	24	29 · 37	50
EMSKV 25 EMV-Z RW	10104306	M 25x1,5	7	9 · 17	29	33 · 42	50
EMSKV 32 EMV-Z RW	10104307	M 32x1,5	8	13 · 21	36	36 · 44	25
EMSKV 50 EMV-Z RW	10104308	M 50x1,5	9	21 · 35	55	51 · 62	10
EMSKV 40 EMV-Z RW	10104309	M 40x1,5	8	16 · 28	46	44 · 55	10
EMSKV 63 EMV-Z RW	10104310	M 63x1,5	10	34 · 48	68	56 · 67	10
EMSKV 75 EMV-Z RW	10104311	M 75x1,5	12	48 · 63	82	67 · 81	1

Empfohlenes Zubehör



EADR

EMMU-EMV

BS

RDE RW

MFD RW

SPRINT EMV Railway Kabelverschraubungen LowTemp mit Erdungseinsatz DIN 89345, EMSKV LT EMV-Z RW, Messing vernickelt, metrisch, EN 45545

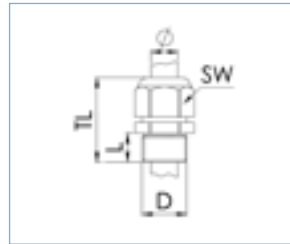

EMSKV LT EMV-Z RW



Schutzart
Einsatztemperatur
Hazard level EN gem. 45545
Material

IP68 (5 bar 30 min) / IP69
 -60 °C · 100 °C
 R22=HL1 / R23=HL2
 Verschraubung Messing vernickelt, Klemmkäfig Polyamid UL94-V0,
 Erdungseinsatz Messing verchromt, Dichtung Silikon

Type	WISKA-No. Ni					TL (mm)	
EMSKV 12 LT EMV-Z RW	10105848	M 12x1,5	5	3 · 7	16	23 · 30	50
EMSKV 16 LT EMV-Z RW	10105849	M 16x1,5	5	4,5 · 10	20	26 · 34	50
EMSKV 20 LT EMV-Z RW	10105850	M 20x1,5	6	6 · 13	24	29 · 37	50
EMSKV 25 LT EMV-Z RW	10105851	M 25x1,5	7	9 · 17	29	33 · 42	50
EMSKV 32 LT EMV-Z RW	10105852	M 32x1,5	8	13 · 21	36	36 · 44	25
EMSKV 40 LT EMV-Z RW	10105853	M 40x1,5	8	16 · 28	46	44 · 55	10
EMSKV 50 LT EMV-Z RW	10105854	M 50x1,5	9	21 · 35	55	51 · 62	10
EMSKV 63 LT EMV-Z RW	10105855	M 63x1,5	10	34 · 48	68	56 · 67	10
EMSKV 75 LT EMV-Z RW	10105856	M 75x1,5	12	48 · 63	82	67 · 81	1

Empfohlenes Zubehör



KABEL-VER-SCHRAU-BUNGEN
 KUNST-STOFF
 METALL
 MARTITIM
 EMV
 EX E/I
 EX D
 RAILWAY
 DRUCKKAUS-GLEICH / VENTING
 BRITISH STANDARD
 DICH-TUNGEN
 MEMBRAN-EINFÜH-RUNGEN
 MEMBRAN
 KABEL-EINFÜH-RUNGS-SYSTEM
 CONMAXX
 CONMAXX TEILB-VER-SCHRAU-BUNG
 KABEL-SCHUTZ
 BRACE FITTING KUNST-STOFF
 BRACE CONDUIT KUNST-STOFF
 BRACE FITTING METALL
 BRACE CONDUIT METALL
 BRACE SLEEVE

SPRINT Railway Kabelverschraubungen, ESSKV RW, Edelstahl, metrisch, EN 45545

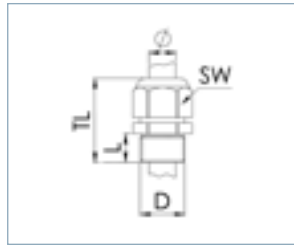

ESSKV RW



Schutzart

IP68 (5 bar 30 min) / IP69

Einsatztemperatur

-40 °C · 100 °C

Hazard level EN gem. 45545

R22=HL3 / R23=HL3

Material

Verschraubung Edelstahl A2 (1.4305), Klemmkäfig Polyamid UL94-V0, Dichtung EPDM

Type	WISKA-No.	D (mm)	(mm)	(mm)	SW (mm)	TL (mm)	
ESSKV 12 RW	10105832	M 12x1,5	5	3 · 7	17	23 · 30	10
ESSKV 16 RW	10105833	M 16x1,5	5	4,5 · 10	22	26 · 34	10
ESSKV 20 RW	10105834	M 20x1,5	6	6 · 13	24	29 · 37	10
ESSKV 25 RW	10105835	M 25x1,5	7	9 · 17	30	33 · 42	10
ESSKV 32 RW	10105836	M 32x1,5	8	13 · 21	36	36 · 44	5
ESSKV 40 RW	10105837	M 40x1,5	8	16 · 28	46	44 · 55	5
ESSKV 50 RW	10105838	M 50x1,5	9	21 · 35	55	51 · 62	2
ESSKV 63 RW	10105839	M 63x1,5	10	34 · 48	68	56 · 67	1

Empfohlenes Zubehör



EADR

BS

ESMU

RDE RW

MFD RW

SPRINT Railway Kabelverschraubungen LowTemp, ESKV LT RW, Edelstahl, metrisch, EN 45545

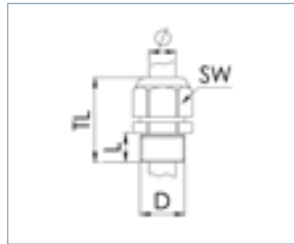

ESKV LT RW



Schutzart
Einsatztemperatur
Hazard level EN gem. 45545
Material

IP68 (5 bar 30 min) / IP69
 -60 °C · 100 °C
 R22=HL1 / R23=HL2
 Verschraubung Edelstahl A2 (1.4305), Klemmkäfig Polyamid UL94-V0,
 Dichtung Silikon

Type	WISKA-No.					TL (mm)	
ESKV 12 LT RW	10105840	M 12x1,5	5	3 - 7	17	23 - 30	10
ESKV 16 LT RW	10105841	M 16x1,5	5	4,5 - 10	22	26 - 34	10
ESKV 20 LT RW	10105842	M 20x1,5	6	6 - 13	24	29 - 37	10
ESKV 25 LT RW	10105843	M 25x1,5	7	9 - 17	30	33 - 42	10
ESKV 32 LT RW	10105844	M 32x1,5	8	13 - 21	36	36 - 44	5
ESKV 40 LT RW	10105845	M 40x1,5	8	16 - 28	46	44 - 55	5
ESKV 50 LT RW	10105846	M 50x1,5	9	21 - 35	55	51 - 62	2
ESKV 63 LT RW	10105847	M 63x1,5	10	34 - 48	68	56 - 67	1

Empfohlenes Zubehör



RDE LT

BS

ESMU

ORD-S

KABEL-
VER-
SCHRAU-
BUNGEN

KUNST-
STOFF

METALL

MARTIM

ENV

EX E/I

EX D

RAILWAY

DRUCKAUS-
GLEICH /
VENTING

BRITISH
STANDARD

DICH-
TUNGEN

MEMBRAN-
EINFÜH-
RUNGEN

MEMBRAN

KABEL-
EINFÜH-
RUNGS-
SYSTEM

CONMAXX

CONMAXX
TEILB. VER-
SCHRAU-
BUNG

KABEL-
SCHUTZ

BRACE
FITTING
KUNST-
STOFF

BRACE
CONDUIT
KUNST-
STOFF

BRACE
FITTING
METALL

BRACE
CONDUIT
METALL

BRACE
SLEEVE

SPRINT EMV Railway Kabelverschraubungen mit Erdungseinsatz DIN 89345, ESKV EMV-Z RW, Edelstahl, metrisch, EN 45545

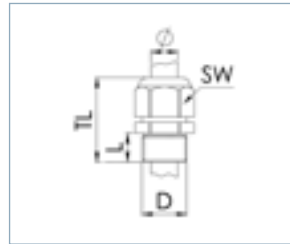

ESSKV EMV-Z RW



Schutzart IP68 (5 bar 30 min) / IP69
Einsatztemperatur -40 °C · 100 °C
Hazard level EN gem. 45545 R22=HL3 / R23=HL3
Material Verschraubung Edelstahl A2 (1.4305), Klemmkäfig Polyamid UL94-V0, Erdungseinsatz Messing verchromt, Dichtung EPDM

Type	WISKA-No.	(mm)	(mm)	(mm)	(mm)	TL (mm)	
ESSKV 12 EMV-Z RW	10105857	M 12x1,5	5	3 · 7	17	23 · 30	10
ESSKV 16 EMV-Z RW	10105858	M 16x1,5	5	4,5 · 10	22	26 · 34	10
ESSKV 20 EMV-Z RW	10105859	M 20x1,5	6	6 · 13	24	29 · 37	10
ESSKV 25 EMV-Z RW	10105860	M 25x1,5	7	9 · 17	30	33 · 42	10
ESSKV 32 EMV-Z RW	10105861	M 32x1,5	8	13 · 21	36	36 · 44	5
ESSKV 40 EMV-Z RW	10105862	M 40x1,5	8	16 · 28	46	44 · 55	5
ESSKV 50 EMV-Z RW	10105863	M 50x1,5	9	21 · 35	55	51 · 62	2
ESSKV 63 EMV-Z RW	10105864	M 63x1,5	10	34 · 48	68	56 · 67	1



SPRINT EMV Railway Kabelverschraubungen LowTemp mit Erdungseinsatz DIN 89345, ESKV LT EMV-Z RW, Edelstahl, metrisch, EN 45545

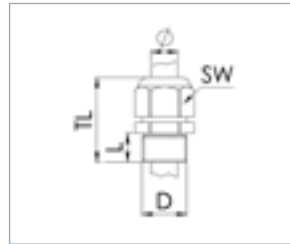

ESSKV LT EMV-Z RW



Schutzart

Einsatztemperatur

Hazard level EN gem. 45545

Material

IP68 (5 bar 30 min) / IP69

-60 °C · 100 °C

R22=HL1 / R23=HL2

Verschraubung Edelstahl A2 (1.4305), Klemmkäfig Polyamid UL94-V0, Erdungseinsatz Messing verchromt, Dichtung Silikon

Type	WISKA-No.					TL (mm)	
ESSKV 12 LT EMV-Z RW	10105865	M 12x1,5	5	3 · 7	17	23 · 30	10
ESSKV 16 LT EMV-Z RW	10105866	M 16x1,5	5	4,5 · 10	22	26 · 34	10
ESSKV 20 LT EMV-Z RW	10105867	M 20x1,5	6	6 · 13	24	29 · 37	10
ESSKV 25 LT EMV-Z RW	10105868	M 25x1,5	7	9 · 17	30	33 · 42	10
ESSKV 32 LT EMV-Z RW	10105869	M 32x1,5	8	13 · 21	36	36 · 44	5
ESSKV 40 LT EMV-Z RW	10105870	M 40x1,5	8	16 · 28	46	44 · 55	5
ESSKV 50 LT EMV-Z RW	10105871	M 50x1,5	9	21 · 35	55	51 · 62	2
ESSKV 63 LT EMV-Z RW	10105872	M 63x1,5	10	34 · 48	68	56 · 67	1

Empfohlenes Zubehör



RDE LT

BS

ESMU

ORD-S

KABEL-VER-SCHRAU-BUNGEN
KUNST-STOFF
METALL
MARITIM
EMV
EX E/I
EX D
RAILWAY
DRUCKAUS-GLEICH / VENTING
BRITISH STANDARD
DICHTUNGEN
MEMBRAN-EINFÜHRUNGEN
MEMBRAN
KABEL-EINFÜHRUNGS-SYSTEM
CONMAXX
CONMAXX TEIL-VER-SCHRAU-BUNG
KABEL-SCHUTZ
BRACE FITTING KUNST-STOFF
BRACE CONDUIT KUNST-STOFF
BRACE FITTING METALL
BRACE CONDUIT METALL
BRACE SLEEVE

SPRINT Dichtungen



MFD RW



RDE RW







Schutzart IP66 / IP68
Einsatztemperatur -40 °C - 100 °C
Material Thermoplastisches Elastomer
Hinweis Weitere Größen auf Anfrage

MFD RW

Type	WISKA-No.	 (mm)			
MFD 12/02/020 RW	10105927	1 · 2	2	SPRINT 12	25
MFD 12/04/020 RW	10105928	1,5 · 2	4	SPRINT 12	25
MFD 16/02/040 RW	10105929	2 · 4	2	SPRINT 16	25
MFD 16/03/021 RW	10105930	1 · 2,1	3	SPRINT 16	25
MFD 20/02/050 RW	10105931	4 · 5	2	SPRINT 20	25
MFD 20/03/040 RW	10105932	2,5 · 4	3	SPRINT 20	25
MFD 25/02/070 RW	10105549	5 · 7	2	SPRINT 25	25
MFD 25/02/070-01/040 RW	10105550	3 · 7	3	SPRINT 25	25
MFD 25/02/080 RW	10105548	6 · 8	2	SPRINT 25	25
MFD 32/01/115-01/050 RW	10105553	4 · 11,5	2	SPRINT 32	25
MFD 32/03/080 RW	10105552	6 · 8	3	SPRINT 32	25
MFD 32/04/080 RW	10105547	6 · 8	4	SPRINT 32	25
MFD 40/02/120-01/070 RW	10105546	7 · 12	3	SPRINT 40	25
MFD 40/04/100 RW	10105933	8 · 10	4	SPRINT 40	25
MFD 40/07/070 RW	10105934	5 · 7	7	SPRINT 40	25
MFD 50/09/080 RW	10105935	6 · 8	9	SPRINT 50	25
MFD 50/25/050 RW	10105936	4 · 5	25	SPRINT 50	25
MFD 63/03/065 RW	10105937	5 · 6,5	3	SPRINT 63	25
MFD 75/03/220 RW	10105588	20 · 22	3	SPRINT 75	25

RDE RW

Type	WISKA-No.	 (mm)			
RDE 12 RW	10105370	1 · 3		SPRINT 12	50
RDE 16 RW	10105371	2 · 6		SPRINT 16	50
RDE 20 RW	10105372	4 · 8		SPRINT 20	50
RDE 25 RW	10105373	7 · 12		SPRINT 25	25
RDE 32 RW	10105374	9 · 14		SPRINT 32	25
RDE 40 RW	10105375	12 · 20		SPRINT 40	10
RDE 50 RW	10105376	16 · 25		SPRINT 50	10
RDE 63 RW	10105377	28 · 38		SPRINT 63	10



Druckausgleich mit Venting

Zur Reduzierung von Ausfällen technischer Geräte auf Grund von Kondenswasser bieten Ihnen unsere Venting-Produkte einen optimalen Druckausgleich. Ob Kabelverschraubungen oder Druckausgleichselemente - ihre luftdurchlässige Membran sorgt für einen Druckausgleich zwischen Innen- und Außenumgebung und ist resistent gegen UV-Einstrahlung, Öle, Fette und Salzwasser.

VentGLAND® Kabelverschraubungen SPRINT, ESVG, Kunststoff, metrisch, EN 62444

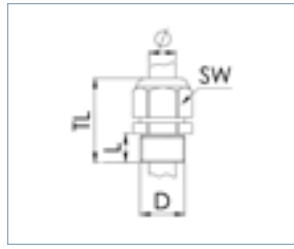

ESVG



Schutzart IP68 / IP69
Glühdrahtprüfung 750 °C
Einsatztemperatur -40 °C - 100 °C
Material Verschraubung Polyamid, Dichtung EPDM, Membran ePTFE

Type	WISKA-No. RAL 7035 LG	WISKA-No. RAL 9005 BK	D (mm)	h (mm)	(mm)	SW (mm)	TL (mm)	U/h	
ESVG 16	10104412	10104413	M 16x1,5	9	4,5 · 10	20	37 · 43	52	1
ESVG 20	10060974	10060802	M 20x1,5	10	6 · 13	24	41 · 50	42	1
ESVG 25	10100666	10100667	M 25x1,5	10	9 · 17	29	45 · 54	65	1
ESVG 32	10100801	10100802	M 32x1,5	12	13 · 21	36	49 · 58	115	1
ESVG 40	10102471	10102472	M 40x1,5	12	16 · 28	46	52 · 65	150	1

Empfohlenes Zubehör



EMUG

RDE

EADR

BS

MFD

VentGLAND® Kabelverschraubungen SPRINT, EMSVG, Messing vernickelt, metrisch, EN 62444



EMSVG

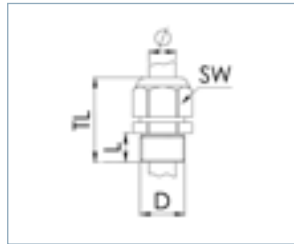

Schutzart IP68 / IP69
Einsatztemperatur -40 °C - 100 °C
Material Verschraubung Messing vernickelt, Dichtung EPDM, Klemmkäfig Polyamid, Membran ePTFE

Type	WISKA-No. Ni	D (mm)	L (mm)	(mm)	SW (mm)	TL (mm)	V/h	
EMSVG 16	10065899	M 16x1,5	6	4,5 - 10	20	34 - 42	52	1
EMSVG 20	10065900	M 20x1,5	6	6 - 13	24	41 - 50	55	1
EMSVG 25	10065901	M 25x1,5	7	9 - 17	29	43 - 52	90	1
EMSVG 32	10065902	M 32x1,5	8	13 - 21	36	47 - 56	115	1
EMSVG 40	10065903	M 40x1,5	8	16 - 28	46	57 - 70	150	1
EMSVG 50	10065904	M 50x1,5	9	21 - 35	55	64 - 77	225	1
EMSVG 63	10065905	M 63x1,5	10	34 - 48	68	69 - 83	285	1

Empfohlenes Zubehör

RDE EMMU BS

- KABEL-VER-SCHRAU-BUNGEN
- KUNST-STOFF
- METALL
- MARTIM
- EMV
- EX E/I
- EX D
- RAILWAY
- DRUCKAUS-GLEICH / VENTING
- BRITISH STANDARD
- DICH-TUNGEN
- MEMBRAN-EINFÜH-RUNGEN
- MEMBRAN
- KABEL-EINFÜH-RUNGS-SYSTEM
- CONMAXX
- CONMAXX-TEILB-VER-SCHRAU-BUNG
- KABEL-SCHUTZ
- BRACE FITTING KUNST-STOFF
- BRACE CONDUIT KUNST-STOFF
- BRACE FITTING METALL
- BRACE CONDUIT METALL
- BRACE SLEEVE

VentGLAND® Kabelverschraubungen SPRINT, ESSVG, Edelstahl, metrisch, EN 62444



ESSVG



ESSVG-4

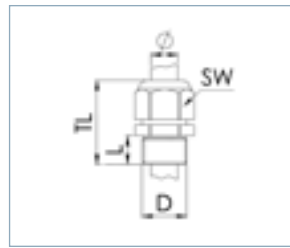

Schutzart IP68 / IP69
Einsatztemperatur -40 °C - 100 °C
Material Verschraubung Edelstahl A2, Dichtung EPDM, Klemmkäfig Polyamid, Membran ePTFE

ESSVG, Edelstahl 1.4305

Type	WISKA-No.					TL (mm)	U/h	
ESSVG 16	10104410	M 16x1,5	6	4,5 - 10	20	34 - 42	52	1
ESSVG 20	10069400	M 20x1,5	6	6 - 13	24	41 - 50	55	1
ESSVG 25	10069401	M 25x1,5	7	9 - 17	30	43 - 52	90	1
ESSVG 32	10069402	M 32x1,5	8	13 - 21	36	47 - 56	115	1
ESSVG 40	10069403	M 40x1,5	8	16 - 28	46	57 - 70	150	1
ESSVG 50	10069404	M 50x1,5	9	21 - 35	55	64 - 77	225	1
ESSVG 63	10069405	M 63x1,5	10	34 - 48	68	69 - 83	285	1

ESSVG-4, Edelstahl 1.4404

Type	WISKA-No.					TL (mm)	U/h	
ESSVG-4 16	10104411	M 16x1,5	6	4,5 - 10	20	34 - 42	52	1
ESSVG-4 20	10069500	M 20x1,5	6	6 - 13	24	41 - 50	55	1
ESSVG-4 25	10069501	M 25x1,5	7	9 - 17	30	43 - 52	90	1
ESSVG-4 32	10069502	M 32x1,5	8	13 - 21	36	47 - 56	115	1
ESSVG-4 40	10069503	M 40x1,5	8	16 - 28	46	57 - 70	150	1
ESSVG-4 50	10069504	M 50x1,5	9	21 - 35	55	64 - 77	225	1
ESSVG-4 63	10069505	M 63x1,5	10	34 - 48	68	69 - 83	285	1

Empfohlenes Zubehör



RDE

BS

ESMU

VentGLAND® EMV Kabelverschraubungen SPRINT mit Kontaktfedereinsatz, EMSVG EMV-S, Messing vernickelt, metrisch, EN 62444



EMSVG EMV-S

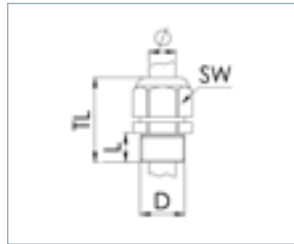

Schutzart IP68 / IP69
Einsatztemperatur -40 °C - 100 °C
Material Verschraubung Messing vernickelt, Klemmkäfig Polyamid, Dichtung EPDM, Membran ePTFE, Erdungseinsatz Edelstahl 1.4310

Type	WISKA-No. Ni	D (mm)	L (mm)	(mm)	SW (mm)	l/h	TL (mm)	
EMSVG 20 EMV-S	10102715	M 20x1,5	6	6 - 13	24	55	41 - 50	1
EMSVG 25 EMV-S	10102716	M 25x1,5	7	9 - 17	29	90	43 - 52	1
EMSVG 32 EMV-S	10102717	M 32x1,5	8	13 - 21	36	115	47 - 56	1
EMSVG 40 EMV-S	10102718	M 40x1,5	8	16 - 28	46	150	57 - 70	1
EMSVG 50 EMV-S	10102719	M 50x1,5	9	21 - 35	55	225	64 - 77	1
EMSVG 63 EMV-S	10102720	M 63x1,5	10	34 - 48	68	285	69 - 83	1

Empfohlenes Zubehör



RDE

EMMU-EMV

BS

KABEL-
VER-
SCHRAU-
BUNGEN

KUNST-
STOFF

METALL

MARTIM

EMV

EX E/I

EX D

RAILWAY

DRUCKAUS-
GLEICH /
VENTING

BRITISH
STANDARD

DICH-
TUNGEN

MEMBRAN-
EINFÜH-
RUNGEN

MEMBRAN

KABEL-
EINFÜH-
RUNGS-
SYSTEM

CONMAXX

CONMAXX
TEILB. VER-
SCHRAU-
BUNG

KABEL-
SCHUTZ

BRACE
FITTING
KUNST-
STOFF

BRACE
CONDUIT
KUNST-
STOFF

BRACE
FITTING
METALL

BRACE
CONDUIT
METALL

BRACE
SLEEVE

VentPLUG Druckausgleichstopfen, EVPS, Kunststoff, metrisch



EVPS 12



EVPS 12 HF



EVPS 20

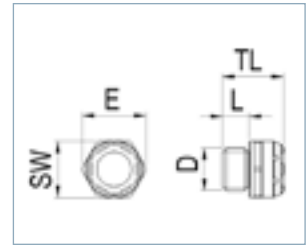

Schutzart IP68 / IP69
Einsatztemperatur -40 °C - 100 °C
Material Polyamid, Dichtung TPE, Membran ePTFE

EVPS

Type	WISKA-No. RAL 7035 LG	WISKA-No. RAL 9005 BK			E (mm)		l/h	TL (mm)	
EVPS 12	10102369	10102370	M 12x1,5	8	18	16	22	17,4	10
EVPS 20	10106591	10106595	M 20x1,5	9	27	24	110	15,4	10
EVPS 40	10106593	10106597	M 40x1,5	9	51	46	660	15,4	10

EVPS HF, High Air Flow

Type	WISKA-No. RAL 7035 LG	WISKA-No. RAL 9005 BK			E (mm)		l/h	TL (mm)	
EVPS 12 HF	10103263	10103264	M 12x1,5	8	18	16	34	17,4	10
EVPS 20 HF	10106615	10106619	M 20x1,5	9	27	24	280	15,4	10
EVPS 40 HF	10106617	10106621	M 40x1,5	9	51	46	1650	15,4	10

EVPS-L, lang

Type	WISKA-No. RAL 7035 LG	WISKA-No. RAL 9005 BK			E (mm)		l/h	TL (mm)	
EVPS-L 20	10106592	10106596	M 20x1,5	15	27	24	110	21,4	10
EVPS-L 40	10106594	10106598	M 40x1,5	18	51	46	660	24,4	10

EVPS-L HF, High Air Flow, lang

Type	WISKA-No. RAL 7035 LG	WISKA-No. RAL 9005 BK			E (mm)		l/h	TL (mm)	
EVPS-L 20 HF	10106616	10106620	M 20x1,5	15	27	24	280	21,4	10
EVPS-L 40 HF	10106618	10106622	M 40x1,5	18	51	46	1650	24,4	10

VentPLUG Druckausgleichstopfen, EMVPS, Messing vernickelt, metrisch



EMVPS



EMVPS HF

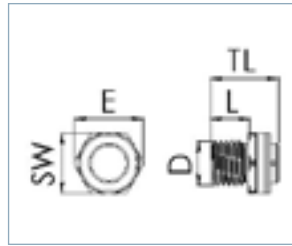

Schutzart IP68 / IP69
Einsatztemperatur -40 °C - 100 °C
Material Messing vernickelt, Dichtung EPDM, Membran ePTFE

EMVPS

Type	WISKA-No. Ni	D (mm)	L (mm)	E (mm)	SW (mm)	l/h	TL (mm)	
EMVPS 12	10103265	M 12x1,5	10	18	16	22	17,5	10

EMVPS HF, High Air Flow

Type	WISKA-No. Ni	D (mm)	L (mm)	E (mm)	SW (mm)	l/h	TL (mm)	
EMVPS 12 HF	10103266	M 12x1,5	10	18	16	34	17,5	10

- KABEL-VER-SCHRAU-BUNGEN
- KUNST-STOFF
- METALL
- MARITIM
- EMV
- EX E/I
- EX D
- RAILWAY
- DRUCK-AUS-GLEICH / VENTING
- BRITISH STANDARD
- DICH-TUNGEN
- MEMBRAN-EINFÜH-RUNGEN
- MEMBRAN
- KABEL-EINFÜH-RUNGS-SYSTEM
- CONMAXX
- CONMAXX TEILB. VER-SCHRAU-BUNG
- KABEL-SCHUTZ
- BRACE FITTING KUNST-STOFF
- BRACE CONDUIT KUNST-STOFF
- BRACE FITTING METALL
- BRACE CONDUIT METALL
- BRACE SLEEVE



British Standard-Kabelverschraubungen

Auf Grund der Verwendung spezieller Kabel kommen bei Installationen in Großbritannien und den Ländern des Commonwealth besondere Ausführungen von Kabelverschraubungen zum Einsatz. Diese folgen dem British Standard (BS) 6121.



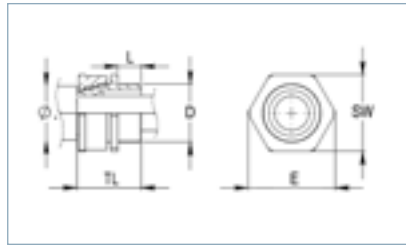



Verschraubungssets, BW Pack, Messing, BS 6121









BW / BWP Pack

Schutzart IP20
Einsatztemperatur -80 °C - 300 °C
Material Messing

BWP Pack, Premium

Type	WISKA-No. Blank	 D (mm)	 L (mm)	 (mm)	 (mm)	 SW (mm)	TL (mm)	
BWP 20S Pack	50101701	M 20x1,5	10	- 15,8	-11,8	22	29	2
BWP 20 Pack	50101702	M 20x1,5	10	- 20,8	-13,8	27	34	2
BWP 25 Pack	50101703	M 25x1,5	10	- 27,5	-19,8	34	36	2
BWP 32 Pack	50101704	M 32x1,5	10	- 33,5	-26,4	41	39	2
BWP 40 Pack	50101705	M 40x1,5	15	- 40,9	-32,4	50	46	1
BWP 50S Pack	50101706	M 50x1,5	15	- 46,3	-38	59	48	1
BWP 50 Pack	50101707	M 50x1,5	15	- 52,6	-44	65	48	1
BWP 63S Pack	50101708	M 63x1,5	15	- 61,5	-49	75	54	1
BWP 63 Pack	50101709	M 63x1,5	15	- 65,3	-55,5	80	54	1
BWP 75S Pack	50101710	M 75x1,5	20	- 73	-62	90	62	1
BWP 75 Pack	50101711	M 75x1,5	20	- 78	-67	95	62	1
BWP 90 Pack	50101712	M 90x1,5	20	- 90	-79	106	66	1

BW Pack, Economy

Type	WISKA-No. Blank	 D (mm)	 L (mm)	 (mm)	 (mm)	 SW (mm)	TL (mm)	
BW 20S Pack	50101693	M 20x1,5	10	- 15,5		21	29	2
BW 20L Pack	50101694	M 20x1,5	10	- 18,3		24	29	2
BW 25 Pack	50101695	M 25x1,5	10	- 25,4		32	34	2
BW 32 Pack	50101696	M 32x1,5	10	- 32,2		38	34	2
BW 40 Pack	50101697	M 40x1,5	15	- 38,5		47	43	1
BW 50 Pack	50101698	M 50x1,5	15	- 52		60	45	1
BW 63 Pack	50101699	M 63x1,5	15	- 64,7		74	50	1
BW 75 Pack	50101700	M 75x1,5	20	- 70		90	62	1

Verschraubungssets, CW Pack, Messing, BS 6121



CW / CWP Pack

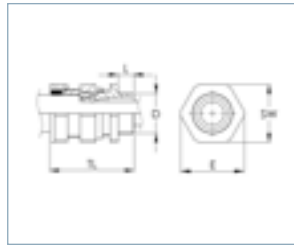







Schutzart IP66
Einsatztemperatur -20 °C · 80 °C
Material Messing

CWP Pack, Premium, für armierte Kabel, Einzeladerschirmung

Type	WISKA-No. Blank	 D (mm)	 L (mm)	 (mm)	 (mm)	 SW (mm)	TL (mm)	
CWP 20SS Pack	50101680	M 20x1,5	10	8,4 · 13,8	-9	22	48	2
CWP 20S Pack	50101681	M 20x1,5	10	12,9 · 15,8	-11,8	24	50	2
CWP 20 Pack	50101682	M 20x1,5	10	15,5 · 20,8	-13,8	30	51	2
CWP 25 Pack	50101683	M 25x1,5	10	20,3 · 27,5	-19,8	38	58	2
CWP 32 Pack	50101684	M 32x1,5	10	26,7 · 33,5	-26,4	46	58	2
CWP 40 Pack	50101685	M 40x1,5	15	33 · 40,9	-32,4	55	77	1
CWP 50S Pack	50101686	M 50x1,5	15	39,4 · 46,3	-38	60	82	1
CWP 50 Pack	50101687	M 50x1,5	15	45,7 · 52,6	-44	65	82	1
CWP 63S Pack	50101688	M 63x1,5	15	52,1 · 61,5	-44	75	88	1
CWP 63 Pack	50101689	M 63x1,5	15	58,4 · 65,3	-55,5	80	88	1
CWP 75S Pack	50101690	M 75x1,5	20	64,8 · 73	-62	90	100	1
CWP 75 Pack	50101691	M 75x1,5	20	71 · 78	-67	95	100	1
CWP 90 Pack	50101692	M 90x1,5	20	81 · 90	-79	110	115	1

CW Pack, Economy

Type	WISKA-No. Blank	 D (mm)	 L (mm)	 (mm)	 (mm)	 SW (mm)	TL (mm)	
CW 20S Pack	50101673	M 20x1,5	10	12,8 · 15,5	-11,8	24	48	2
CW 20L Pack	50101674	M 20x1,5	10	15,5 · 19,5	-13,6	27	50	2
CW 25 Pack	50101675	M 25x1,5	10	23 · 26,5	-20	35	57	2
CW 32 Pack	50101676	M 32x1,5	10	28 · 33,5	-26,5	46	62	2
CW 40 Pack	50101677	M 40x1,5	15	34 · 39,5	-32,1	53	69	1
CW 50 Pack	50101678	M 50x1,5	15	46 · 52	-42,2	63	73	1
CW 63 Pack	50101679	M 63x1,5	15	60 · 66	-55,2	80	82	1





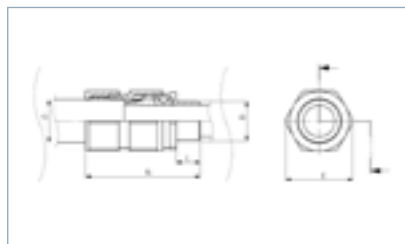

KABEL-VER-SCHRAU-BUNGEN
 KUNST-STOFF
 METALL
 MARTITIM
 EMV
 EX E/I
 EX D
 RAILWAY
 BRÜCKEN-DRUCKKAUS-GLEICH / VENTING
 BRITISH STANDARD
 DICH-TUNGEN
 MEMBRAN-EINFÜH-RUNGEN
 MEMBRAN
 KABEL-EINFÜH-RUNGS-SYSTEM
 CONMAXX
 CONMAXX TEILB-VER-SCHRAU-BUNG
 KABEL-SCHUTZ
 BRACE FITTING KUNST-STOFF
 BRACE CONDUIT KUNST-STOFF
 BRACE FITTING METALL
 BRACE CONDUIT METALL
 BRACE SLEEVE

Verschraubungssets für armierte Kabel, E1W Pack, Premium, Einzeladerschirmung, Messing, BS 6121



E1W Pack

Schutzart IP66 / 68
Einsatztemperatur -20 °C - 80 °C
Material Messing





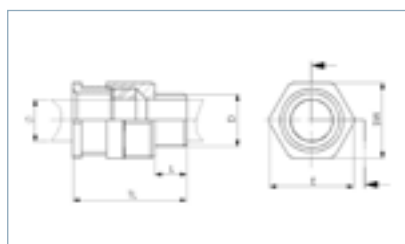

Type	WISKA-No. Blank	 D (mm)	 L (mm)	 (mm)	 (mm)	 SW (mm)	TL (mm)	
E1W 20S Pack	50101655	M 20x1,5	15	12,9 - 15,8	8 - 11,8	24	63	2
E1W 20 Pack	50101656	M 20x1,5	15	15,5 - 20,8	11 - 13,8	30	67	2
E1W 25 Pack	50101657	M 25x1,5	15	20,3 - 27,5	13 - 19,8	38	76	2
E1W 32 Pack	50101658	M 32x1,5	15	26,7 - 33,5	19 - 26,4	46	80	2
E1W 40 Pack	50101659	M 40x1,5	20	33 - 40,9	25 - 32,4	55	86	1
E1W 50 Pack	50101660	M 50x1,5	20	39,4 - 46,3	31,5 - 38	60	94	1
E1W 50L Pack	50101661	M 50x1,5	20	45,7 - 52,6	36,5 - 44	65	94	1
E1W 63S Pack	50101662	M 63x1,5	20	52,1 - 61,5	42,5 - 49	75	103	1
E1W 63L Pack	50101663	M 63x1,5	20	58,4 - 65,3	48,5 - 55,5	80	103	1
E1W 75S Pack	50101664	M 75x1,5	20	64,8 - 73	54,5 - 62	90	106	1
E1W 75 Pack	50101665	M 75x1,5	20	71 - 78	60,5 - 67	95	106	1

Verschraubungssets für Kabel mit Geflechschirmung, CXTP Pack, Premium, Messing, BS 6121



CXTP Pack

Schutzart IP66
Einsatztemperatur -20 °C - 80 °C
Material Messing

Type	WISKA-No. Blank	 D (mm)	 L (mm)	 (mm)	 (mm)	 SW (mm)	TL (mm)	
CXTP 20S Pack	50101666	M 20x1,5	15	7 - 11,6		24	40	2
CXTP 20L Pack	50101667	M 20x1,5	15	10,5 - 13,6		27	40	2
CXTP 25 Pack	50101668	M 25x1,5	15	12,5 - 19,8		36	49	2
CXTP 32 Pack	50101669	M 32x1,5	15	18,5 - 26,3		41	49	2
CXTP 40 Pack	50101670	M 40x1,5	20	25 - 32,1		50	51	1
CXTP 50 Pack	50101671	M 50x1,5	20	30,5 - 38,1		60	51	1
CXTP 63 Pack	50101672	M 63x1,5	20	36,5 - 44		75	69	1



Dichtungen

Unser umfangreiches Sortiment aus Reduzier-, Mehrfach- und Sonderdichtungen ist mit allen Kabelverschraubungen und Materialien aus unserem SPRINT Kabelverschraubungssystem kombinierbar und erfüllt dabei mindestens IP66. Neben individuellen Ausführungen halten wir auch verschiedene Materialien für spezielle Einsätze wie z. B. Niedrigtemperaturen für Sie bereit.



SPRINT Reduzierdichteinsätze, RDE



RDE



Schutzart IP68
Einsatztemperatur -40 °C - 100 °C
Farbe Schwarz
Material EPDM

Type	WISKA-No. RAL 9005 BK	 (mm)		
RDE 12	10062183	1 - 3	SPRINT 12	50
RDE 16	10062184	2 - 6	SPRINT 16	50
RDE 20	10062185	4 - 8	SPRINT 20	50
RDE 25	10060768	7 - 12	SPRINT 25	25
RDE 32	10062186	9 - 14	SPRINT 32	25
RDE 40	10062187	12 - 20	SPRINT 40	10
RDE 50	10062188	16 - 25	SPRINT 50	10
RDE 63	10062189	28 - 38	SPRINT 63	10

KABEL-VER-SCRAUBUNGEN
 KUNST-STOFF
 METALL
 MARTIN
 EW/
 EX E/
 EX D
 RAILWAY
 DRUCKAUSGLEICH / VENTING
 BRITISH STANDARD
 DICHTUNGEN
 MEMBRAN-EINFÜHRUNGEN
 MEMBRAN
 KABEL-EINFÜHRUNGSSYSTEM
 CONNMAXX
 CONNMAXX TEIL-VER-SCHRAUBUNG
 KABEL-SCHUTZ
 BRACE FITTING KUNST-STOFF
 BRACE CONDUIT KUNST-STOFF
 BRACE FITTING METALL
 BRACE CONDUIT METALL
 BRACE SLEEVE



SPRINT Reduzierdichteinsätze LowTemp, RDE LT



RDE LT



Schutzart IP68
Einsatztemperatur -60 °C - 100 °C
Farbe Rot
Material Silikon

Type	WISKA-No. RAL 3000 RD	 (mm)		
RDE 12 LT	10063981	1 - 3	SPRINT 12	50
RDE 16 LT	10063908	2 - 6	SPRINT 16	50
RDE 20 LT	10063909	4 - 8	SPRINT 20	50
RDE 25 LT	10063910	7 - 12	SPRINT 25	25
RDE 32 LT	10063934	9 - 14	SPRINT 32	25
RDE 40 LT	10063960	12 - 20	SPRINT 40	10
RDE 50 LT	10063966	16 - 25	SPRINT 50	10
RDE 63 LT	10063967	28 - 38	SPRINT 63	10

KABEL-VER-SCHRAUBUNGEN
KUNST-STOFF
METALL
MARTITIM
ENV
EX E/I
EX D
RAILWAY
BRÜCKAUS-GLEICH / VENTING
BRITISH STANDARD
DICH-TUNGEN
MEMBRAN-EINFÜHRUNGEN
MEMBRAN
KABEL-EINFÜHRUNGS-SYSTEM
CONMAXX
CONMAXX-TEILB-VER-SCHRAUBUNG
KABEL-SCHUTZ
BRACE FITTING KUNST-STOFF
BRACE CONDUIT KUNST-STOFF
BRACE FITTING METALL
BRACE CONDUIT METALL
BRACE SLEEVE





SPRINT Mehrfachdichtungen, MFD







MFD



Schutzart IP66 / 68
Einsatztemperatur -40 °C - 100 °C
Material Thermoplastisches Elastomer
Hinweis IP68 : Ø Kabel min. = Ø Kabel max. -10%, aber nicht größer als 1 mm unter dem Ø Kabel max.

Type	WISKA-No. RAL 9005 BK	 (mm)	 n		
MFD 12/01/015	10102489	1 - 1,5	1	SPRINT 12	25
MFD 12/02/020	10100525	1 - 2	2	SPRINT 12	25
MFD 12/04/020	10064392	1,5 - 2	4	SPRINT 12	25
MFD 16/02/040	10064393	2 - 4	2	SPRINT 16	25
MFD 16/03/021	10101014	1 - 2,1	3	SPRINT 16	25
MFD 20/01/090	10102841	8 - 9	1	SPRINT 20	25
MFD 20/02/050	10101015	4 - 5	2	SPRINT 20	25
MFD 20/02/060	10064395	4 - 6	2	SPRINT 20	25
MFD 20/02/065	10060953	5 - 6,5	2	SPRINT 20	25
MFD 20/03/040	10064341	2,5 - 4	3	SPRINT 20	25
MFD 20/03/045	10102306	2,5 - 4,5	3	SPRINT 20	25
MFD 20/04/030	10102722	2 - 3	4	SPRINT 20	25
MFD 20/05/030	10102853	2 - 3	5	SPRINT 20	25
MFD 25/01/065	10060954	4 - 6,5	1	SPRINT 25	25
MFD 25/01/090	10101016	7 - 9	1	SPRINT 25	25
MFD 25/01/105-01/055	10101255	5 - 10,5	2	SPRINT 25	25
MFD 25/02/030	10102655	2 - 3	2	SPRINT 25	25
MFD 25/02/060	10060452	4 - 6	2	SPRINT 25	25
MFD 25/02/070	10063995	5 - 7	2	SPRINT 25	25
MFD 25/02/070-01/040	10102979	3 - 7	3	SPRINT 25	25
MFD 25/02/080	10060952	6 - 8	2	SPRINT 25	25
MFD 25/03/045	10103325	3,5 - 4,5	3	SPRINT 25	25
MFD 25/03/070	10064342	5 - 7	3	SPRINT 25	25
MFD 25/04/060	10064343	4 - 6	4	SPRINT 25	25
MFD 25/05/056	10102023	4,5 - 5,6	5	SPRINT 25	25
MFD 32/01/060-02/090	10103653	5 - 9	3	SPRINT 32	25
MFD 32/01/115-01/050	10102794	4 - 11,5	2	SPRINT 32	25
MFD 32/01/115-01/085	10101256	8 - 11,5	2	SPRINT 32	25
MFD 32/02/080	10102743	7 - 8	2	SPRINT 32	25
MFD 32/02/85	10102493	7,5 - 8,5	2	SPRINT 32	25
MFD 32/03/065	10102169	4,5 - 6,5	3	SPRINT 32	25
MFD 32/03/080	10101018	6 - 8	3	SPRINT 32	25
MFD 32/03/090	10102170	7 - 9	3	SPRINT 32	25
MFD 32/04/070	10064344	5 - 7	4	SPRINT 32	25
MFD 32/05/070	10101140	5 - 7	5	SPRINT 32	25
MFD 32/04/080	10064950	6 - 8	4	SPRINT 32	25
MFD 32/06/060	10064345	5 - 6	6	SPRINT 32	25
MFD 40/02/070-01/100-02/115	10102765	6 - 11,5	5	SPRINT 40	25
MFD 40/02/120-01/070	10102488	7 - 12	3	SPRINT 40	25
MFD 40/03/125	10102054	11,5 - 12,5	3	SPRINT 40	25
MFD 40/04/100	10101017	8 - 10	4	SPRINT 40	25
MFD 40/06/065	10102171	5,5 - 6,5	6	SPRINT 40	25
MFD 40/06/090	10102172	7,5 - 9	6	SPRINT 40	25
MFD 40/07/070	10064348	5 - 7	7	SPRINT 40	25

Type	WISKA-No. RAL 9005 BK	 (mm)	 n		
MFD 40/07/080	10064347	6 - 8	7	SPRINT 40	25
MFD 40/08/060	10064346	5 - 6	8	SPRINT 40	25
MFD 40/08/070	10102744	6 - 7	8	SPRINT 40	25
MFD 40/09/069	10101427	6 - 7	9	SPRINT 40	25
MFD 50/09/080	10064394	6 - 8	9	SPRINT 50	25
MFD 50/15/050	10102745	4 - 5	15	SPRINT 50	25
MFD 50/16/060	10102746	5 - 6	16	SPRINT 50	25
MFD 50/25/050	10063102	4 - 5	25	SPRINT 50	25
MFD 63/01/131-01/118-03/084-02	10101114	6 - 13	7	SPRINT 63	25
MFD 63/02/065-01/090	10101223	5 - 9	3	SPRINT 63	25
MFD 63/03/065	10101201	5 - 6,5	3	SPRINT 63	25

Weitere Größen auf Anfrage

SPRINT Sonderdichtungen



GFD



FFD





SFD



Schutzart IP66
Einsatztemperatur -40 °C - 100 °C
Material Thermoplastisches Elastomer



FFD, für Flachkabel

Type	WISKA-No. RAL 9005 BK	 n		
FFD 20/01/510	10064322	1	SPRINT 20	25
FFD 20/01/713	10101192	1	SPRINT 20	25
FFD 25/01/816	10103326	1	SPRINT 25	25

SFD, für ASi-Bus-Leitungen

Type	WISKA-No. RAL 9005 BK	 n		
SFD 20/01/ASi	10064329	1	SPRINT 20	25

GFD, geteilt, für konfektionierte Kabel

Type	WISKA-No. RAL 9005 BK	 n		
GFD 20/01/015	10064328	1	SPRINT 20	25
GFD 20/01/060	10102297	1	SPRINT 20	25
GFD 25/01/050	10101019	1	SPRINT 25	25
GFD 25/01/060	10066632	1	SPRINT 25	25
GFD 32/01/045-01/085	10101145	2	SPRINT 32	25
GFD 32/01/073	10102359	1	SPRINT 32	25
GFD 50/01/080	10101020	1	SPRINT 50	25
GFD 63/01/090	10101536	1	SPRINT 63	25
GFD 63/02/065-01/090	10101224	3	SPRINT 63	25
GFD 63/03/065	10101200	3	SPRINT 63	25

Weitere Größen auf Anfrage

KABEL-VER-SCHRAUBUNGEN
 KUNST-STOFF
 METALL
 MARTITIM
 EMV
 EX E/I
 EX D
 RAILWAY
 DRUCKAUS-GLEICH / VENTING
 BRITISH STANDARD
 DICH-TUNGEN
 MEMBRAN-EINFÜHRUNGEN
 MEMBRAN
 KABEL-EINFÜHRUNGSSYSTEM
 CONMAXX
 CONMAXX-TEILB-VER-SCHRAUBUNG
 KABEL-SCHUTZ
 BRACE FITTING KUNST-STOFF
 BRACE CONDUIT KUNST-STOFF
 BRACE FITTING METALL
 BRACE CONDUIT METALL
 BRACE SLEEVE



SPRINT Blindstopfen, BS



BS



Einsatztemperatur -60 °C - 100 °C
Farbe Rot
Material Polyamid

Type	WISKA-No.	 (mm)	TL (mm)	
BS 2	10064000	2	12	50
BS 3	10064001	3	12	50
BS 4	10064002	4	12	50
BS 5	10064003	5	12	50
BS 6	10064004	6	16	50
BS 7	10064005	7	16	50
BS 8	10064006	8	16	50
BS 9	10064007	9	16	50
BS 10	10064008	10	16	50
BS 12	10064009	12	22	50
BS 13	10064010	13	22	50
BS 14	10064011	14	22	50
BS 17	10064012	17	22	50
BS 20	10064013	20	22	25
BS 21	10064014	21	30	25
BS 25	10064015	25	30	25
BS 28	10064016	28	30	25
BS 35	10064017	35	35	10
BS 38	10064018	38	35	10
BS 48	10064019	48	35	10
BS 63	10064020	63	35	5

SPRINT Anschlussgewindedichtringe



EADR / ADR





EADR LT





Einsatztemperatur -40 °C - 140 °C

Material EPDM



EADR, SPRINT, metrisch, -40°C - 140°C

Type	WISKA-No. RAL 9005 BK		TL (mm)	
EADR 12	10062801	M 12x1,5	2	100
EADR 16	10062802	M 16x1,5	2	100
EADR 20	10062803	M 20x1,5	2	100
EADR 25	10062804	M 25x1,5	2	100
EADR 32	10062805	M 32x1,5	2	100
EADR 40	10062806	M 40x1,5	2	100
EADR 50	10062807	M 50x1,5	2	100
EADR 63	10062808	M 63x1,5	2	100

EADR LT, LowTemp, SPRINT, metrisch, -60°C - 140°C

Type	WISKA-No. RAL 3000 RD		TL (mm)	
EADR 12/90 LT	10105704	M 12x1,5	2	100
EADR 16/90 LT	10105705	M 16x1,5	2	100
EADR 20/90 LT	10105706	M 20x1,5	2	100
EADR 25/90 LT	10105707	M 25x1,5	2	100
EADR 32/90 LT	10105708	M 32x1,5	2	100
EADR 40/90 LT	10105709	M 40x1,5	2	100
EADR 50/90 LT	10105710	M 50x1,5	2	100
EADR 63/90 LT	10105711	M 63x1,5	2	100

ADR, PG, -40°C - 140°C

Type	WISKA-No. RAL 9005 BK		TL (mm)	
ADR 7	10061419	PG 7	2	100
ADR 9	10061420	PG 9	2	100
ADR 11	10061421	PG 11	2	100
ADR 13,5	10061422	PG 13,5	2	100
ADR 16	10061423	PG 16	2	100
ADR 21	10061424	PG 21	3	100
ADR 29	10061425	PG 29	3	100
ADR 36	10061426	PG 36	3	100
ADR 42	10061427	PG 42	3	100
ADR 48	10061428	PG 48	3	100

SPRINT O-Ringe, ORD



ORD-E



ORD-V



ORD-S



ORD-E, EPDM, -40 °C · 120 °C, schwarz

Type	WISKA-No.			
ORD-E 12	10064697	SPRINT 12	M 12x1,5	100
ORD-E 16	10064698	SPRINT 16	M 16x1,5	100
ORD-E 20	10064699	SPRINT 20	M 20x1,5	100
ORD-E 25	10064700	SPRINT 25	M 25x1,5	100
ORD-E 32	10064701	SPRINT 32	M 32x1,5	100
ORD-E 40	10064702	SPRINT 40	M 40x1,5	100
ORD-E 50	10064703	SPRINT 50	M 50x1,5	100
ORD-E 63	10064704	SPRINT 63	M 63x1,5	100
ORD-E 75	10101765	SPRINT 75	M 75x1,5	100

ORD-V, Viton, -15 °C · 200 °C, schwarz

Type	WISKA-No.			
ORD-V 12	10064705	SPRINT 12	M 12x1,5	100
ORD-V 16	10064706	SPRINT 16	M 16x1,5	100
ORD-V 20	10064707	SPRINT 20	M 20x1,5	100
ORD-V 25	10064708	SPRINT 25	M 25x1,5	100
ORD-V 32	10064709	SPRINT 32	M 32x1,5	100
ORD-V 40	10064710	SPRINT 40	M 40x1,5	100
ORD-V 50	10064711	SPRINT 50	M 50x1,5	100
ORD-V 63	10064712	SPRINT 63	M 63x1,5	100

ORD-S, Silikon, -60 °C · 180 °C, blau

Type	WISKA-No.			
ORD-S 12	10101757	SPRINT 12	M 12x1,5	100
ORD-S 16	10101758	SPRINT 16	M 16x1,5	100
ORD-S 20	10101759	SPRINT 20	M 20x1,5	100
ORD-S 25	10101760	SPRINT 25	M 25x1,5	100
ORD-S 32	10101761	SPRINT 32	M 32x1,5	100
ORD-S 40	10101762	SPRINT 40	M 40x1,5	100
ORD-S 50	10101763	SPRINT 50	M 50x1,5	100
ORD-S 63	10101764	SPRINT 63	M 63x1,5	100



Membran-Kabeleinführungen

Wenn Kabel möglichst einfach und schnell eingeführt werden müssen, kommen Membran-Kabeleinführungen zum Einsatz. Sie haben eine platzsparende Bauform und sind für verschiedene Kabel flexibel einsetzbar. Wir fertigen unsere IP66 und IP67 Membran-Kabeleinführungen im Zweikomponentenspritzguss in Kaltenkirchen.

CLIXX Membran-Kabeleinführungen mit Zugentlastung

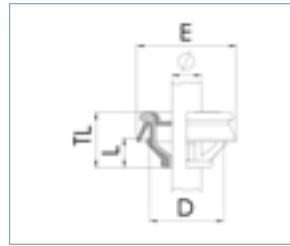

CLIXX



Schutzart IP66 / 67
Einsatztemperatur -40 °C - 65 °C
Material Polypropylen, Membrane TPE

Type	WISKA-No. RAL 7035 LG	WISKA-No. RAL 9001 WH	WISKA-No. RAL 3000 RD	WISKA-No. RAL 9005 BK			DD (mm)		TL (mm)	
CLIXX 16	10101861	10101932	10101931	10101930	16	4,5 - 10	16,7	0,8 - 3,5	15	50
CLIXX 20	10101359	10101935	10101934	10101933	20	6 - 13	20,7	0,8 - 3,5	15	50
CLIXX 25	10101862	10101938	10101937	10101936	25	9 - 17	25,7	0,8 - 3,5	15	50

MultiCLIXX Mehrfach-Membraneinführung mit Zugentlastung, EMTZ

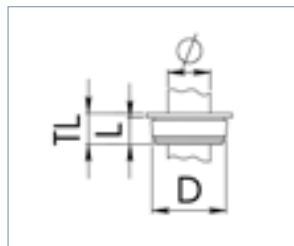

EMTZ



Schutzart IP66
Glühdrahtprüfung 960 °C
Einsatztemperatur -30 °C - 80 °C
Material Polypropylen, Membrane TPE

Type	WISKA-No.				TL (mm)	DD (mm)	
EMTZ 32/02/120-02/080 V0	10108616	32	9,5	4 - 12	12	32,5	50

QUIXX Membran-Kabeleinführungen, EMS, metrisch



EMS



EMS

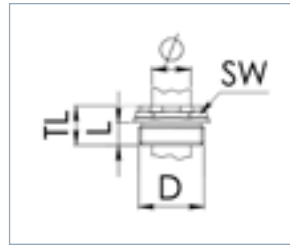

Schutzart IP66
Einsatztemperatur -30 °C - 80 °C
Material Polypropylen, Membrane TPE

Type	WISKA-No. RAL 7035 LG	D (mm)	L (mm)	Ø (mm)	SW (mm)	TL (mm)	
EMS 16	10062567	M 16x1,5	9	1 - 9	17	15	100
EMS 20	10062568	M 20x1,5	9	1 - 13	20	15	100
EMS 25	10062569	M 25x1,5	9	1 - 18	24	15	100
EMS 32	10062570	M 32x1,5	9	1 - 25	32	15	100

Empfohlenes Zubehör



EMUG

EADR

QUIXX Membran-Kabeleinführungen, EMT



EMT



EMT

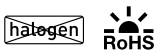
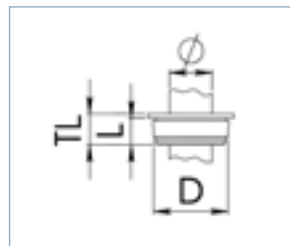

Schutzart IP66
Einsatztemperatur -40 °C - 80 °C
Material Thermoplastisches Elastomer

Type	WISKA-No. RAL 7035 LG	D (mm)	L (mm)	Ø (mm)	TL (mm)	S (mm)	DD (mm)	
EMT 16	10062559	16	9,5	1 - 9	11	2	16,5	100
EMT 20	10062560	20	9,5	1 - 13	11	2	20,5	100
EMT 25	10062561	25	9,5	1 - 18	11	2	25,5	100
EMT 32	10062562	32	9,5	1 - 25	11	2	32,5	100

KABEL-VER-SCHRAUBUNGEN
 KUNST-STOFF
 METALL
 MARTITIM
 ENV
 EX E/I
 EX D
 RAILWAY
 DRUCKKAUS-GLEICH / VENTING
 BRITISH STANDARD
 DICH-TUNGEN
 MEMBRAN-EINFÜHRUNGEN
 MEMBRAN
 KABEL-EINFÜHRUNGS-SYSTEM
 CONMAXX
 CONMAXX TEILB-VER-SCHRAUBUNG
 KABEL-SCHUTZ
 BRACE FITTING KUNST-STOFF
 BRACE CONDUIT KUNST-STOFF
 BRACE FITTING METALL
 BRACE CONDUIT METALL
 BRACE SLEEVE

QUIXX Membran-Kabeleinführungen flammwidrig, EMT-F

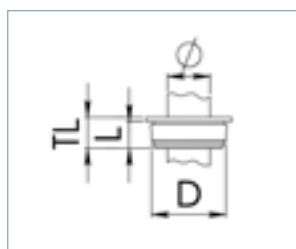

EMT-F



Schutzart IP66
Glühdrahtprüfung 960 °C
Einsatztemperatur -40 °C - 80 °C
Material TPE, flammwidrig

Type	WISKA-No. weiß				TL (mm)			
EMT-F 16	10063008	16	9,5	1 · 9	11	2	16,5	100
EMT-F 20	10063009	20	9,5	1 · 13	11	2	20,5	100
EMT-F 25	10063010	25	9,5	1 · 18	11	2	25,5	100
EMT-F 32	10063011	32	9,5	1 · 25	11	2	32,5	100

FLIP Dichtungsdurchführungen, FD

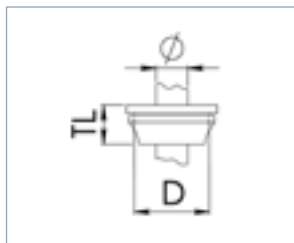

FD



Schutzart IP66 / 67
Einsatztemperatur -40 °C - 110 °C
Material EPDM

Type	WISKA-No. RAL 9005 BK	WISKA-No. RAL 7001 SG			TL (mm)			
FD 12	50062891	50062770	M 12	4 · 7	13	12 · 13	0,5 · 2	50
FD 16	50062892	50062771	M 16	5 · 9	18	15 · 17	1 · 4	50
FD 20	50062893	50062772	M 20	8 · 13	20	20 · 21	1 · 4	50
FD 25	50062894	50062773	M 25	11 · 17	21,5	25 · 26	1 · 4	50
FD 32	50062895	50062774	M 32	15 · 20	25	32 · 33	1 · 4	25
FD 40	50062896	50062775	M 40	19 · 28	30	40 · 41	1 · 4	25
FD 50	50062897	50062776	M 50	27 · 35	35	50 · 51	1 · 4	10



CONMAXX Kabeleinführungssystem

Mit CONMAXX haben wir ein Kabeleinführungssystem speziell für Schaltschrankinstallationen und Elektrogehäuse entwickelt. Das innovative Drei-Komponenten-Baukastensystem bietet Ihnen eine ganz neue Dimension der Flexibilität. Auf diese Weise sind selbst nachträgliche, einzelne Änderungen an der Verkabelung jederzeit ganz ohne lästiges Auf- und Zuschrauben möglich.

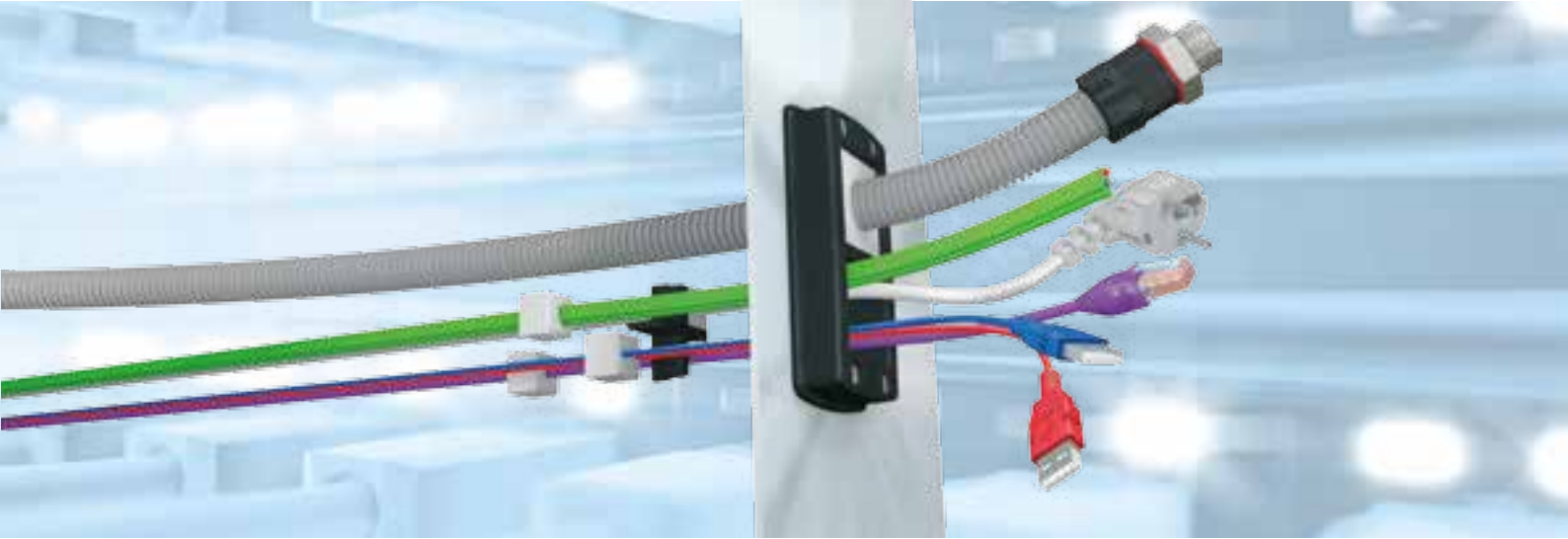

CONMAXX - Ein System - alle Möglichkeiten

Mit CONMAXX haben wir ein Kabeleinführungssystem speziell für Schaltschrankinstallationen und Installationen mit vorkonfektionierten Kabeln entwickelt. Das System besteht aus einem geschlossenen Rahmen, variablen Gittereinsätzen und konischen Dichtelementen. Ergänzt wird es durch die teilbare Kabelverschraubung CONMAXX Gland.

So einfach ist die Installation mit dem CONMAXX-System

Außerhalb des Schaltschranks:

- 1 Installation des Rahmens am Schaltschrankgehäuse von außen

Innerhalb des Schaltschranks:

- 2 Kabel in die Dichtelemente einführen
- 3 Gittereinsatz in den Rahmen schieben
- 4 Dichtelemente mit Kabeln in den Gittereinsatz drücken

CONMAXX System: Ihre Kombinationsmöglichkeiten mit unserem Kabeleinführungssystem

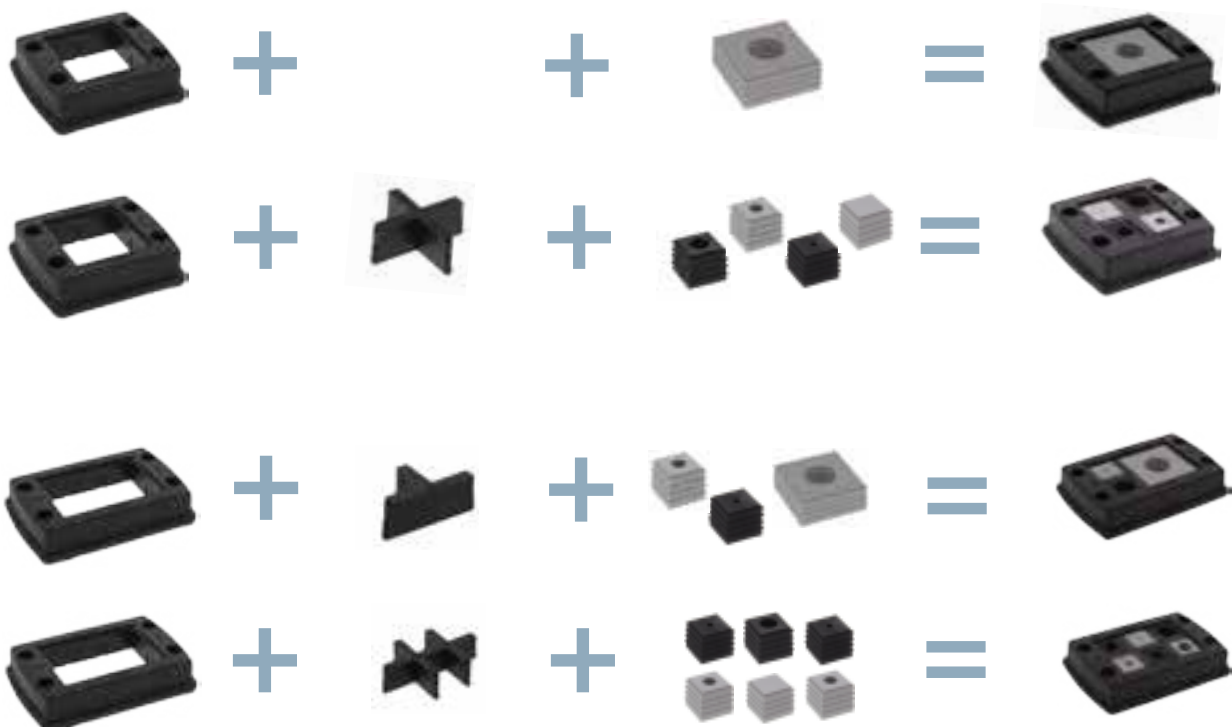

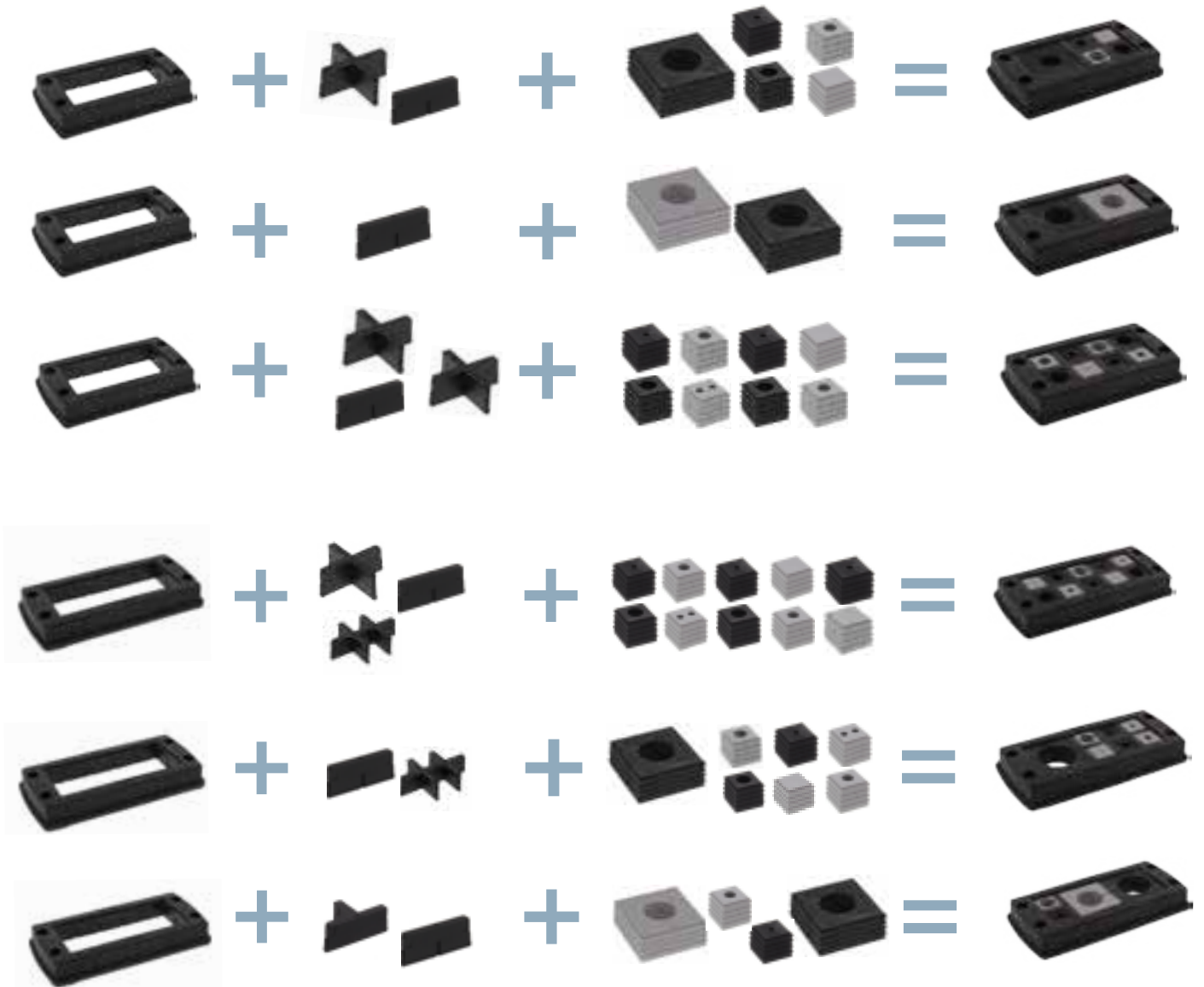

CONMAXX Gland: Ihre Kombinationsmöglichkeiten mit unserer teilbaren Verschraubung

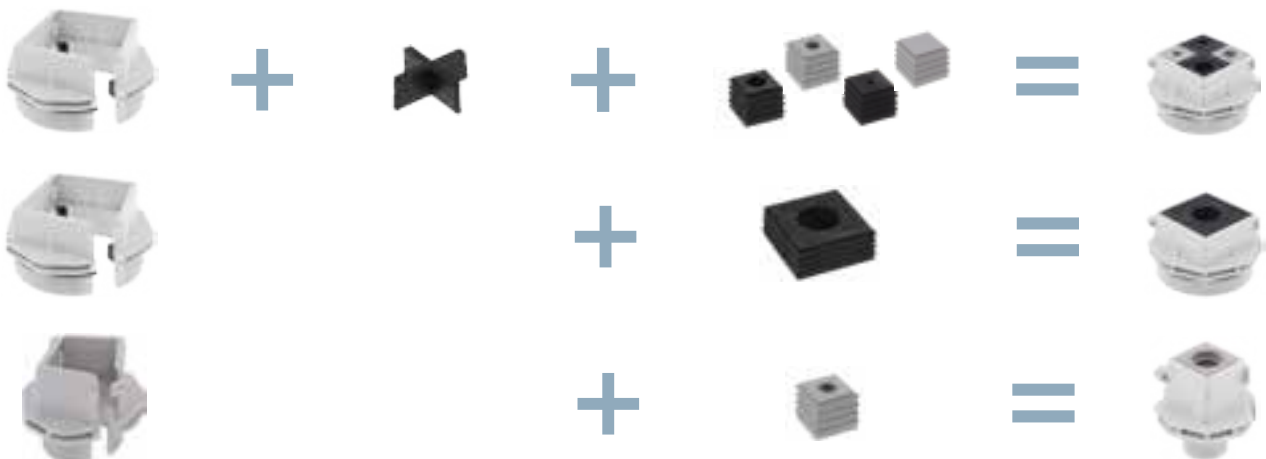

CONMAXX Rahmen und Verriegelungen, Kunststoff



CF



CV



Schutzart IP66
Einsatztemperatur -40 °C - 120 °C
Material Polyamid UL94-V0

CF, Rahmen, schwarz

Type	WISKA-No.	BxL (mm)	
CF 4-B1 V0 BK	10108180	70x81mm	1
CF 6-10 V0 BK	10108181	70x106mm	1
CF 8-16 V0 BK	10108182	70x126mm	1
CF 10-24 V0 BK	10108183	70x153mm	1

CV, Verriegelungsrahmen, schwarz

Type	WISKA-No.	BxL (mm)	
CV 4 V0 BK	10108184	69x80mm	1
CV 6 V0 BK	10108185	69x105mm	1
CV 8 V0 BK	10108186	69x125mm	1
CV 10 V0 BK	10108187	69x152mm	1

Empfohlenes Zubehör

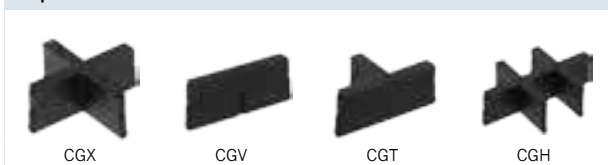

CGX

CGV

CGT

CGH

CONMAXX Steg und T-Gittereinsatz, Kunststoff



CGV



CGT

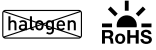
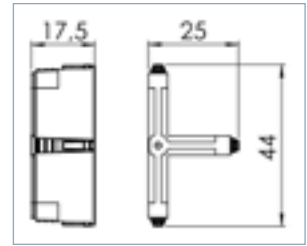
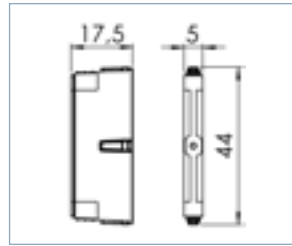

Schutzart IP66
Einsatztemperatur -40 °C - 120 °C
Material Polyamid UL94-V0

CGV

Type	WISKA-No.	
CGV V0 BK	10108188	1

CGT

Type	WISKA-No.	
CGT V0 BK	10108189	1

CONMAXX X- und H-Gittereinsatz, Kunststoff



CGX



CGH

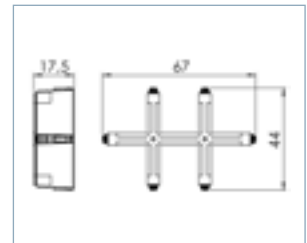
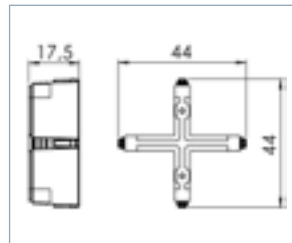

Schutzart IP66
Einsatztemperatur -40 °C - 120 °C
Material Polyamid UL94-V0

CGX

Type	WISKA-No.	
CGX V0 BK	10108190	1

CGH

Type	WISKA-No.	
CGH V0 BK	10108191	1

KABEL-VER-SCHRAUBUNGEN
KUNSTSTOFF
METALL
MARITIM
EMV
EX E/I
EX D
RAILWAY
DRUCKAUSGLEICH / VENTING
BRITISH STANDARD
DICHTUNGEN
MEMBRAN-EINFÜHRUNGEN
MEMBRAN
KABEL-EINFÜHRUNGSSYSTEM
CONMAXX
CONMAXX TEIL-VER-SCHRAUBUNG
KABEL-SCHUTZ
BRACE FITTING KUNSTSTOFF
BRACE CONDUIT KUNSTSTOFF
BRACE FITTING METALL
BRACE CONDUIT METALL
BRACE SLEEVE



CONMAXX Dichteinsätze





CONMAXX Dichteinsätze



Schutzart IP66
Einsatztemperatur RAL 9005 -40 - 120 °C / RAL 7035 -40 - 90 °C
Material Thermoplastisches Elastomer
Hinweis CDK = Kleine Dichteinsätze, CDG = Große Dichteinsätze

Type	WISKA-No. RAL 9005 BK	 (mm)	Bxl (mm)	
CDK 0 HB	10108192		20,7 x 20,7 mm	10
CDKG 2 HB	10108193	2	20,7 x 20,7 mm	10
CDKG 3 HB	10108194	3	20,7 x 20,7 mm	10
CDKG 4 HB	10108195	4	20,7 x 20,7 mm	10
CDKG 5 HB	10108196	5	20,7 x 20,7 mm	10
CDKG 6 HB	10108197	6	20,7 x 20,7 mm	10
CDKG 7 HB	10108198	7	20,7 x 20,7 mm	10
CDKG 8 HB	10108199	8	20,7 x 20,7 mm	10
CDKG 9 HB	10108200	9	20,7 x 20,7 mm	10
CDKG 10 HB	10108201	10	20,7 x 20,7 mm	10
CDKG 11 HB	10108202	11	20,7 x 20,7 mm	10
CDKG 12 HB	10108203	12	20,7 x 20,7 mm	10
CDKG 13 HB	10108204	13	20,7 x 20,7 mm	10
CDKG 14 HB	10108205	14	20,7 x 20,7 mm	10
CDG 0 HB	10108206		43,1 x 43,1 mm	10
CDGG 15 HB	10108207	15	43,1 x 43,1 mm	10
CDGG 16 HB	10108208	16	43,1 x 43,1 mm	10
CDGG 17 HB	10108209	17	43,1 x 43,1 mm	10
CDGG 18 HB	10108210	18	43,1 x 43,1 mm	10
CDGG 19 HB	10108211	19	43,1 x 43,1 mm	10
CDGG 20 HB	10108212	20	43,1 x 43,1 mm	10
CDGG 21 HB	10108213	21	43,1 x 43,1 mm	10
CDGG 22 HB	10108214	22	43,1 x 43,1 mm	10
CDGG 23 HB	10108215	23	43,1 x 43,1 mm	10
CDGG 24 HB	10108216	24	43,1 x 43,1 mm	10
CDGG 25 HB	10108217	25	43,1 x 43,1 mm	10
CDGG 26 HB	10108218	26	43,1 x 43,1 mm	10
CDGG 27 HB	10108219	27	43,1 x 43,1 mm	10
CDGG 28 HB	10108220	28	43,1 x 43,1 mm	10
CDGG 29 HB	10108221	29	43,1 x 43,1 mm	10
CDGG 30 HB	10108222	30	43,1 x 43,1 mm	10
CDGG 31 HB	10108223	31	43,1 x 43,1 mm	10
CDGG 32 HB	10108224	32	43,1 x 43,1 mm	10
CDGG 33 HB	10108225	33	43,1 x 43,1 mm	10
CDKS 2-15 HB	10108226	15	20,7 x 20,7 mm	10
CDGS 15-34 HB	10108227	34	43,1 x 43,1 mm	10
CDKG 2x4-5 HB	10108228	5	20,7 x 20,7 mm	10
CDKG 2x5-6 HB	10108229	6	20,7 x 20,7 mm	10
CDKG 4x2-3 HB	10108230	3	20,7 x 20,7 mm	10
CDKG 4x3-4 HB	10108231	4	20,7 x 20,7 mm	10
CDKG/1xASI HB	10108232		20,7 x 20,7 mm	10
CDKG/2xASI HB	10108233		20,7 x 20,7 mm	10

Type	WISKA-No. RAL 7035 LG	 (mm)	BxL (mm)	
CDK 0 V0	10108234		20,7 x 20,7 mm	10
CDKG 2 V0	10108235	2	20,7 x 20,7 mm	10
CDKG 3 V0	10108236	3	20,7 x 20,7 mm	10
CDKG 4 V0	10108237	4	20,7 x 20,7 mm	10
CDKG 5 V0	10108238	5	20,7 x 20,7 mm	10
CDKG 6 V0	10108239	6	20,7 x 20,7 mm	10
CDKG 7 V0	10108240	7	20,7 x 20,7 mm	10
CDKG 8 V0	10108241	8	20,7 x 20,7 mm	10
CDKG 9 V0	10108242	9	20,7 x 20,7 mm	10
CDKG 10 V0	10108243	10	20,7 x 20,7 mm	10
CDKG 11 V0	10108244	11	20,7 x 20,7 mm	10
CDKG 12 V0	10108245	12	20,7 x 20,7 mm	10
CDKG 13 V0	10108246	13	20,7 x 20,7 mm	10
CDKG 14 V0	10108247	14	20,7 x 20,7 mm	10
CDG 0 V0	10108248		43,1 x 43,1 mm	10
CDGG 15 V0	10108249	15	43,1 x 43,1 mm	10
CDGG 16 V0	10108250	16	43,1 x 43,1 mm	10
CDGG 17 V0	10108251	17	43,1 x 43,1 mm	10
CDGG 18 V0	10108252	18	43,1 x 43,1 mm	10
CDGG 19 V0	10108253	19	43,1 x 43,1 mm	10
CDGG 20 V0	10108254	20	43,1 x 43,1 mm	10
CDGG 21 V0	10108255	21	43,1 x 43,1 mm	10
CDGG 22 V0	10108256	22	43,1 x 43,1 mm	10
CDGG 23 V0	10108257	23	43,1 x 43,1 mm	10
CDGG 24 V0	10108258	24	43,1 x 43,1 mm	10
CDGG 25 V0	10108259	25	43,1 x 43,1 mm	10
CDGG 26 V0	10108260	26	43,1 x 43,1 mm	10
CDGG 27 V0	10108261	27	43,1 x 43,1 mm	10
CDGG 28 V0	10108262	28	43,1 x 43,1 mm	10
CDGG 29 V0	10108263	29	43,1 x 43,1 mm	10
CDGG 30 V0	10108264	30	43,1 x 43,1 mm	10
CDGG 31 V0	10108265	31	43,1 x 43,1 mm	10
CDGG 32 V0	10108266	32	43,1 x 43,1 mm	10
CDGG 33 V0	10108267	33	43,1 x 43,1 mm	10
CDKG 2x4-5 V0	10108268	5	20,7 x 20,7 mm	10
CDKG 2x5-6 V0	10108269	6	20,7 x 20,7 mm	10
CDKG 4x2-3 V0	10108270	3	20,7 x 20,7 mm	10
CDKG 4x3-4 V0	10108271	4	20,7 x 20,7 mm	10
CDKG/1xASI V0	10108272		20,7 x 20,7 mm	10
CDKG/2xASI V0	10108273		20,7 x 20,7 mm	10

- KABEL-VER-SCHRAUBUNGEN
- KUNST-STOFF
- METALL
- MARTITIM
- ENV
- EX E/I
- EX D
- RAILWAY
- DRUCKKAUS-GLEICH / VENTING
- BRITISH STANDARD
- DICH-TUNGEN
- MEMBRAN-EINFÜHRUNGEN
- MEMBRAN
- KABEL-EINFÜHRUNGS-SYSTEM
- CONMAXX
- CONMAXX TEIL-VER-SCHRAUBUNG
- KABEL-SCHUTZ
- BRACE FITTING KUNST-STOFF
- BRACE CONDUIT KUNST-STOFF
- BRACE FITTING METALL
- BRACE CONDUIT METALL
- BRACE SLEEVE

CONMAXX Gland teilbare Kabelverschraubungen mit Gegenmutter, CKM, Kunststoff, metrisch



CKM



Einsatztemperatur -40 °C - 100 °C
Schutzart IP66
Material Verschraubung PA6 UL94-V0, Dichtung TPE UL94-V0

Type	WISKA-No. RAL 7035 LG	D (mm)	L (mm)	SW (mm)	TL (mm)	
CKM 20 V0 LG	10108663	M 20x1,5	15	38	39	1
CKM 25 V0 LG	10108664	M 25x1,5	15	38	39	1
CKM 32 V0 LG	10108665	M 32x1,5	15	38	39	1
CKM 40 V0 LG	10108666	M 40x1,5	15	68	40	1
CKM 50 V0 LG	10108667	M 50x1,5	15	68	40	1
CKM 63 V0 LG	10108668	M 63x1,5	15	68	40	1

CONMAXX Gland teilbare Gegenmuttern, CMM, Kunststoff, metrisch



CMM



Einsatztemperatur -40 °C - 100 °C
Material PA6 UL94-V0

Type	WISKA-No. RAL 7035 LG	D (mm)	SW (mm)	TL (mm)	
CMM 20 V0 LG	10108675	M 20x1,5	27	5	5
CMM 25 V0 LG	10108676	M 25x1,5	32	6	5
CMM 32 V0 LG	10108677	M 32x1,5	40	6	5
CMM 40 V0 LG	10108678	M 40x1,5	50	7	1
CMM 50 V0 LG	10108679	M 50x1,5	60	7	1
CMM 63 V0 LG	10108680	M 63x1,5	75	7	1



Brace Kabelschutz

Mit dem Brace System erweitern wir unser Sortiment um den Bereich des Kabelschutzes. Die Kunststoff-Wellrohrverschraubung BraceFITTING mit integrierter Dichtung aus unserer unternehmenseigenen Produktion erfüllt höchste Qualitätsstandards und wird ergänzt durch ein umfangreiches Kabelschutz-Programm aus Verschraubungen, Schutzschläuchen und Zubehör in Metall und Kunststoff.

BraceFITTING Wellrohrverschraubungen, EBFS, Kunststoff, metrisch

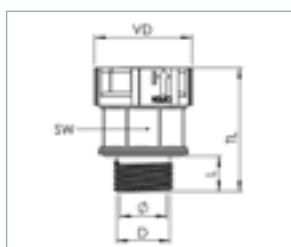

EBFS



Schutzart IP68
Einsatztemperatur -40 °C - 100 °C
Material Verschraubung Polyamid UL94-V0, Dichtung TPU

Type	WISKA-No. RAL 7031 BG	WISKA-No. RAL 9005 BK	NW			VD (mm)			TL (mm)	
EBFS-07-12	10106844	10106861	7	M 12x1,5	10	21,60	6	17	35,1	50
EBFS-10-12	10106845	10106862	10	M 12x1,5	10	24,80	7	20	38,6	50
EBFS-10-16	10106846	10106863	10	M 16x1,5	10	24,80	9	20	39	50
EBFS-12-16	10106847	10106864	12	M 16x1,5	10	27,50	11,50	22	37,2	50
EBFS-12-20	10106848	10106865	12	M 20x1,5	12	27,50	12	22	39,2	50
EBFS-14-20	10106849	10106866	14	M 20x1,5	12	30	12	25	41,5	50
EBFS-17-20	10106850	10106867	17	M 20x1,5	12	32,65	14,80	27	41,5	50
EBFS-17-25	10106851	10106868	17	M 25x1,5	12	32,65	15,50	27	41,5	50
EBFS-23-25	10106852	10106869	23	M 25x1,5	14	42	19	36	50,3	25
EBFS-23-32	10106853	10106870	23	M 32x1,5	14	47,30	19	36	50,3	25
EBFS-29-32	10106854	10106871	29	M 32x1,5	14	47,30	26	41	53	25
EBFS-29-40	10106855	10106872	29	M 40x1,5	14	47,30	26	41	53	25
EBFS-36-40	10106856	10106873	36	M 40x1,5	14	54,90	33,50	50	54,6	10
EBFS-36-50	10106857	10106874	36	M 50x1,5	15	54,90	33,50	50	54,6	10
EBFS-48-50	10106858	10106875	48	M 50x1,5	16	68	42,50	60	56,8	5
EBFS-48-63	10106859	10106876	48	M 63x1,5	16	68	44	60	56,8	5



KABEL-VERSCRAUBUNGEN
 KUNSTSTOFF
 METALL
 MARITIM
 EWV
 EX E/I
 EX D
 RAILWAY
 DRUCKAUSGLEICH / VENTING
 STANDARD
 BRITISH
 DICHTUNG
 MEMBRAN-EINÜBUNG
 MEMBRAN
 KABEL-EINFÜHRUNGSSYSTEM
 CONNMAXX
 CONNMAXX TEILVERSCRAUBUNG
 KABELSCHUTZ
 BRACE FITTING KUNSTSTOFF
 BRACE CONDUIT KUNSTSTOFF
 BRACE FITTING METALL
 BRACE CONDUIT METALL
 BRACE SLEEVE

BraceFITTING Wellrohrverschraubungen, EMBFS, Kunststoff und Messing, metrisch



EMBFS

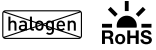
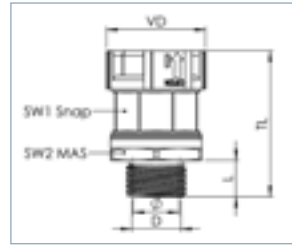

Schutzart IP68
Einsatztemperatur -40 °C - 100 °C
Material Verschraubung Polyamid UL94-V0, Anschlussgewinde Messing vernickelt, Dichtung TPU

Type	WISKA-No. RAL 7031 BG	WISKA-No. RAL 9005 BK	NW	D (mm)	h (mm)	VD (mm)	Ø	SW 1 (mm)	SW 2 (mm)	TL (mm)	
EMBFS-07-12	10106877	10106893	7	M 12x1,5	9,5	21,60	6	17	18	42,1	50
EMBFS-10-16	10106878	10106894	10	M 16x1,5	12	24,80	7	20	22	46,8	50
EMBFS-10-20	10106879	10106895	10	M 20x1,5	12	24,80	7	20	23	46,8	50
EMBFS-12-16	10106880	10106896	12	M 16x1,5	12	27,50	11,50	22	23	46,7	50
EMBFS-12-20	10106881	10106897	12	M 20x1,5	12	27,50	11,50	22	23	46,7	50
EMBFS-14-20	10106882	10106898	14	M 20x1,5	12	30	12	25	26	49	50
EMBFS-17-20	10106883	10106899	17	M 20x1,5	12	32,65	15,20	27	30	49	50
EMBFS-17-25	10106884	10106900	17	M 25x1,5	12	32,65	15,20	27	30	49	50
EMBFS-23-25	10106885	10106901	23	M 25x1,5	12	42	19	36	36	55,8	25
EMBFS-23-32	10106886	10106902	23	M 32x1,5	12	42	19	36	36	55,8	25
EMBFS-29-32	10106887	10106903	29	M 32x1,5	12	47,30	26	41	46	58,5	25
EMBFS-29-40	10106888	10106904	29	M 40x1,5	12	47,30	26	41	46	58,5	25
EMBFS-36-40	10106889	10106905	36	M 40x1,5	12	54,90	33,50	50	50	59,1	10
EMBFS-36-50	10106890	10106906	36	M 50x1,5	14	54,90	33,50	50	55	61,1	10
EMBFS-48-50	10106891	10106907	48	M 50x1,5	14	68	42,50	60	65	62,3	5
EMBFS-48-63	10106892	10106908	48	M 63x1,5	14	68	42,50	60	70	62,3	5



KABEL-VER-SCHRAUBUNGEN
 KUNST-STOFF
 METALL
 MARTITIM
 ENV
 EX E/I
 EX D
 RAILWAY
 DRUCKKAUS-GLEICH / VENTING
 BRITISH STANDARD
 DICH-TUNGEN
 MEMBRAN-EINFÜHRUNGEN
 MEMBRAN
 KABEL-EINFÜHRUNGS-SYSTEM
 CONMAXX
 CONMAXX TEILB-VER-SCHRAUBUNG
 KABEL-SCHUTZ
 BRACE FITTING KUNST-STOFF
 BRACE CONDUIT KUNST-STOFF
 BRACE FITTING METALL
 BRACE CONDUIT METALL
 BRACE SLEEVE

**BraceFITTING Wellrohrverschraubungen mit Innengewinde, EMBFSI, Kunststoff und
Messing, metrisch**

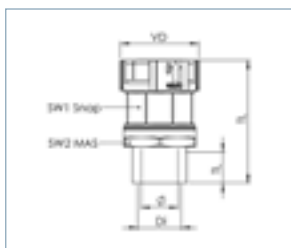

EMBFSI



Schutzart IP68
Einsatztemperatur -40 °C - 100 °C
Material Verschraubung Polyamid UL94-V0, Anschlussgewinde Messing vernickelt, Dichtung TPU

Type	WISKA-No. RAL 7031 BG	WISKA-No. RAL 9005 BK	NW			VD (mm)				TL (mm)	
EMBFSI-10-16	10106914	10106922	10	M 16x1,5	12	24,80	7	20	20	49,9	50
EMBFSI-12-16	10106915	10106923	12	M 16x1,5	12	27,50	11,60	22	24	48,8	50
EMBFSI-12-20	10106916	10106924	12	M 20x1,5	12	27,50	11,60	22	24	48,8	50
EMBFSI-17-20	10106917	10106925	17	M 20x1,5	12	32,70	15,40	27	30	51,2	50
EMBFSI-23-25	10106918	10106926	23	M 25x1,5	13	42	19	36	36	58,1	50
EMBFSI-29-32	10106919	10106927	29	M 32x1,5	13	47,30	26	41	46	60,9	25
EMBFSI-36-40	10106920	10106928	36	M 40x1,5	13	54,90	33,50	50	55	61,5	10
EMBFSI-48-50	10106921	10106929	48	M 50x1,5	13	68	42,50	60	65	62,7	5

Empfohlenes Zubehör



BraceFITTING Wellrohrverschraubungen mit Kabelverschraubung, EMBFSCG, Kunststoff und Messing, metrisch



EMBFSCG



Schutzart IP68
Einsatztemperatur -40 °C - 100 °C
Material Verschraubung Polyamid UL94-V0, Anschlussgewinde Messing vernickelt, Dichtung TPU

Type	WISKA-No. RAL 7031 BG	WISKA-No. RAL 9005 BK	NW			VD (mm)				TL (mm)	
EMBFSCG-10-16	10107371	10107379	10	M 16x1,5	5	24,80	7	20	20	63,7 - 71,7	50
EMBFSCG-12-16	10107372	10107380	12	M 16x1,5	5	27,50	10	22	24	68 - 76	50
EMBFSCG-12-20	10107373	10107381	12	M 20x1,5	6	27,50	10	22	24	64,9 - 72,9	50
EMBFSCG-17-20	10107374	10107382	17	M 20x1,5	6	32,70	13	27	24	66,4 - 74,4	50
EMBFSCG-23-25	10107375	10107383	23	M 25x1,5	7	42	17	36	29	76,8 - 85,8	25
EMBFSCG-29-32	10107376	10107384	29	M 32x1,5	8	47,30	21	41	36	82,2 - 90,2	25
EMBFSCG-36-40	10107377	10107385	36	M 40x1,5	8	54,90	28	50	46	91,3 - 102,3	5
EMBFSCG-48-50	10107378	10107386	48	M 50x1,5	9	68	35	60	55	98,5 - 109,5	5



KABEL-VER-SCHRAU-BUNGEN
 KUNST-STOFF
 METALL
 MARITIM
 ENV
 EX E/I
 EX D
 RAILWAY
 DRUCKAUS-GLEICH / VENTING
 BRITISH STANDARD
 DICH-TUNGEN
 MEMBRAN-EINFÜH-RUNGEN
 MEMBRAN
 KABEL-EINFÜH-RUNGS-SYSTEM
 CONMAXX
 CONMAXX TEILB-VER-SCHRAU-BUNG
 KABEL-SCHUTZ
 BRACE FITTING KUNST-STOFF
 BRACE CONDUIT KUNST-STOFF
 BRACE FITTING METALL
 BRACE CONDUIT METALL
 BRACE SLEEVE

BraceFITTING Wellrohrverschraubungen 45° Winkel, EBF45, Kunststoff, metrisch

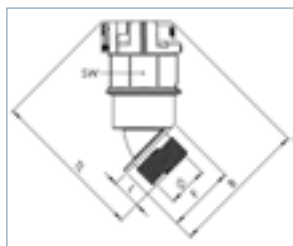

EBF45



Schutzart IP68
Einsatztemperatur -40 °C - 100 °C
Material Verschraubung Polyamid UL94-V0, Dichtung TPU

Type	WISKA-No. RAL 7031 BG	WISKA-No. RAL 9005 BK	NW				VD (mm)		TL (mm)	
EBF45-07-12	10106948	10106956	7	M 12x1,5	9	6	44,8	17	47,2	50
EBF45-10-12	10108870	10108876	10	M 12x1,5	9	7	48,3	20	50,6	50
EBF45-10-16	10106949	10106957	10	M 16x1,5	12	9	51,2	20	53,2	50
EBF45-12-16	10106950	10106958	12	M 16x1,5	12	10,70	51,4	22	53,4	50
EBF45-12-20	10108871	10108877	12	M 20x1,5	12	12	55,1	22	57,2	50
EBF45-17-20	10106951	10106959	17	M 20x1,5	12	13,20	58,7	27	60,8	50
EBF45-17-25	10108872	10108878	17	M 25x1,5	13	15,50	63,3	27	65,1	50
EBF45-23-25	10106952	10106960	23	M 25x1,5	13	18,20	71,6	36	73,4	25
EBF45-23-32	10108873	10108879	23	M 32x1,5	13	19	77,8	36	76,3	25
EBF45-29-32	10106953	10106961	29	M 32x1,5	13	26	81,5	41	80	25
EBF45-29-40	10108874	10108880	29	M 40x1,5	14,5	26	87,2	41	85,8	25
EBF45-36-40	10106954	10106962	36	M 40x1,5	14,5	33,50	90,8	50	89,5	10
EBF45-36-50	10108875	10108881	36	M 50x1,5	16	33,50	98,4	50	95,9	10
EBF45-48-50	10106955	10106963	48	M 50x1,5	16	42,50	103,3	60	100,8	5
EBF45-48-63	10108882	10108883	48	M 63x1,5	17,5	44	110,8	60	104,3	5



KABEL-
VER-
SCRAU-
BUNGEN

KUNST-
STOFF

METALL

MARTIN

EMV

EX E/I

EX D

RAILWAY

DRUCKAUS-
GLEICH /
VENTING

STANDARD

BRITISH

DICH-
TUNGEN

MEMBRAN-
EIN-
U-
RÜNGEN

MEMBRAN

KABEL-
EINFÜH-
RÜNGS-
SYSTEM

CONNMAXX

CONNMAXX
TEIL-
VER-
SCHRAU-
BUNG

KABEL-
SCHUTZ

BRACE
FITTING
KUNST-
STOFF

BRACE
CONDUIT
KUNST-
STOFF

BRACE
FITTING
METALL

BRACE
CONDUIT
METALL

BRACE
SLEEVE

BraceFITTING Wellrohrverschraubungen 45° Winkel, EMBF45, Kunststoff und Messing, metrisch

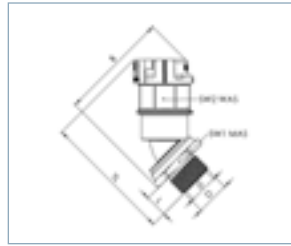

EMBF45



Schutzart IP68
Einsatztemperatur -40 °C · 100 °C
Material Verschraubung PA6, Anschlussgewinde Messing vernickelt, Dichtung TPU

Type	WISKA-No. RAL 7031 BG	WISKA-No. RAL 9005 BK	NW				VD (mm)			TL (mm)	
EMBF45-07-12	10106982	10107318	7	M 12x1,5	9	6	45,8	18	17	55,7	50
EMBF45-10-12	10106983	10107319	10	M 12x1,5	12	7	50,5	20	20	62,1	50
EMBF45-10-16	10106984	10107320	10	M 16x1,5	12	7	51,4	22	20	62	50
EMBF45-12-16	10106985	10107321	12	M 16x1,5	12	10,70	53,2	23	22	63,8	50
EMBF45-12-20	10106986	10107322	12	M 20x1,5	12	10,70	53,3	23	22	63,8	50
EMBF45-17-20	10106987	10107323	17	M 20x1,5	12	13,20	62	30	27	69,4	50
EMBF45-17-25	10106988	10107324	17	M 25x1,5	12	13,20	62,2	30	27	69,3	50
EMBF45-23-25	10106989	10107325	23	M 25x1,5	12	18,20	75,6	36	36	80,9	25
EMBF45-23-32	10106990	10107326	23	M 32x1,5	12	18,20	75,6	36	36	81,9	25
EMBF45-29-32	10106991	10107327	29	M 32x1,5	12	26	86,8	46	41	88,5	25
EMBF45-29-40	10106992	10107328	29	M 40x1,5	12	26	86,1	46	41	87,5	25
EMBF45-36-40	10106993	10107329	36	M 40x1,5	12	33,50	93,8	50	50	96,5	10
EMBF45-36-50	10106994	10107330	36	M 50x1,5	14	33,50	96,6	50	50	98,5	10
EMBF45-48-50	10106995	10107331	48	M 50x1,5	14	42,50	110,3	65	60	107,9	5
EMBF45-48-63	10106996	10107332	48	M 63x1,5	14	42,50	113	70	60	108,3	5



KABEL-VER-SCHRAU-BUNGEN
 KUNST-STOFF
 METALL
 MARTITIM
 ENV
 EX E/I
 EX D
 RAILWAY
 DRUCKKAUS-GLEICH / VENTING
 BRITISH STANDARD
 DICH-TUNGEN
 MEMBRAN-EINFÜH-RUNGEN
 MEMBRAN
 KABEL-EINFÜH-RUNGS-SYSTEM
 CONMAXX
 CONMAXX TEILB-VER-SCHRAU-BUNG
 KABEL-SCHUTZ
 BRACE FITTING KUNST-STOFF
 BRACE CONDUIT KUNST-STOFF
 BRACE FITTING METALL
 BRACE CONDUIT METALL
 BRACE SLEEVE

BraceFITTING Wellrohrverschraubungen 45° Winkel mit Innengewinde, EMBF45I, Kunststoff und Messing, metrisch

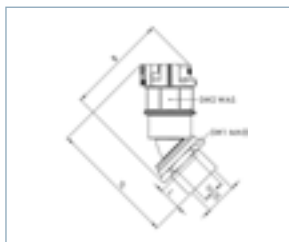

EMBF45I



Schutzart IP68
Einsatztemperatur -40 °C - 100 °C
Material Verschraubung Polyamid UL94-V0, Anschlussgewinde Messing vernickelt, Dichtung TPU

Type	WISKA-No. RAL 7031 BG	WISKA-No. RAL 9005 BK	NW	D (mm)	L (mm)		VD (mm)	SW 1 (mm)	SW 2 (mm)	TL (mm)	
EMBF45I-12-16	10107333	10107340	12	M 16x1,5	12	10	55,3	24	22	70,5	50
EMBF45I-12-20	10107334	10107341	12	M 20x1,5	13	10	55,3	24	22	70,5	50
EMBF45I-17-20	10107335	10107342	17	M 20x1,5	13	15,50	62,3	30	27	72	50
EMBF45I-23-25	10107336	10107343	23	M 25x1,5	13	18	75,8	36	36	88,5	50
EMBF45I-29-32	10107337	10107344	29	M 32x1,5	13	26	87,3	46	41	94	25
EMBF45I-36-40	10107338	10107345	36	M 40x1,5	13	33	97,3	55	50	102,7	10
EMBF45I-48-50	10107339	10107346	48	M 50x1,5	13	42	111,2	65	60	114,2	10

Empfohlenes Zubehör



BraceCONDUIT Wellrohr aus Kunststoff

BraceFITTING Wellrohrverschraubungen 45° Winkel mit Kabelverschraubung, EMBF45CG, Kunststoff und Messing, metrisch

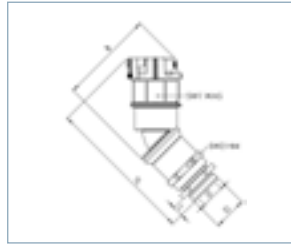

EMBF45CG



Schutzart IP68
Einsatztemperatur -40 °C · 100 °C
Material Verschraubung Polyamid UL94-V0, Anschlussgewinde Messing vernickelt, Dichtung TPU

Type	WISKA-No. RAL 7031 BG	WISKA-No. RAL 9005 BK	NW	D (mm)	L (mm)	VD (mm)	Ø	B (mm)	SW 1 (mm)	SW 2 (mm)	TL (mm)	
EMBF45CG-12-16	10107987	10107993	12	M 16x1,5	5	25	10	55,3	22	24	90,2 · 98,2	50
EMBF45CG-17-20	10107988	10107994	17	M 20x1,5	6	30,40	13	60,7	27	24	89,8 · 97,8	50
EMBF45CG-23-25	10107989	10107995	23	M 25x1,5	7	39,40	17	71,8	36	29	107,9 · 116,9	25
EMBF45CG-29-32	10107990	10107996	29	M 32x1,5	8	44,40	21	82	41	36	116,8 · 124,8	25
EMBF45CG-36-40	10107991	10107997	36	M 40x1,5	8	53,40	28	92,1	50	46	132,6 · 143,6	5
EMBF45CG-48-50	10107992	10107998	48	M 50x1,5	9	65,80	35	105,2	60	55	150,8 · 161,8	5



KABEL-VER-SCHRAU-BUNGEN
KUNST-STOFF
METALL
MARTITIM
EMV
EX E/I
EX D
RAILWAY
BRÜCKHAUS-GLEICH / VENTING
BRITISH STANDARD
DICH-TUNGEN
MEMBRAN-EINFÜH-RUNGEN
MEMBRAN
KABEL-EINFÜH-RUNGS-SYSTEM
CONMAXX
CONMAXX TEILB-VER-SCHRAU-BUNG
KABEL-SCHUTZ
BRACE FITTING KUNST-STOFF
BRACE CONDUIT KUNST-STOFF
BRACE FITTING METALL
BRACE CONDUIT METALL
BRACE SLEEVE

BraceFITTING Wellrohrverschraubungen 90° Winkel, EBF90, Kunststoff, metrisch

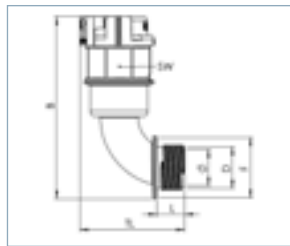

EBF90



Schutzart IP68
Einsatztemperatur -40 °C - 100 °C
Material Verschraubung Polyamid UL94-V0, Dichtung TPU

Type	WISKA-No. RAL 7031 BG	WISKA-No. RAL 9005 BK	NW	D (mm)	h (mm)	Ø	VD (mm)	SW (mm)	TL (mm)	
EBF90-07-12	10106966	10106974	7	M 12x1,5	9	6	64,8	17	32	50
EBF90-10-12	10108884	10108891	10	M 12x1,5	9	7	68	20	33,6	50
EBF90-10-16	10106967	10106975	10	M 16x1,5	10,5	9	71,9	20	36,7	50
EBF90-12-16	10106968	10106976	12	M 16x1,5	10,5	10,50	71,9	22	36,7	50
EBF90-12-20	10108885	10108892	12	M 20x1,5	12	13	76,3	22	40,8	50
EBF90-17-20	10106969	10106977	17	M 20x1,5	12	13	78,6	27	43,5	50
EBF90-17-25	10108886	10108893	17	M 25x1,5	13	15,50	85,1	27	50	50
EBF90-23-25	10106970	10106978	23	M 25x1,5	13	19	92,4	36	51,5	25
EBF90-23-32	10108887	10108894	23	M 32x1,5	13	19	100,9	36	55,5	25
EBF90-29-32	10106971	10106979	29	M 32x1,5	13	26	103,6	41	58	25
EBF90-29-40	10108888	10108895	29	M 40x1,5	14,5	26	118,8	41	69,3	25
EBF90-36-40	10106972	10106980	36	M 40x1,5	14,5	33,50	119,4	50	74,8	10
EBF90-36-50	10108889	10108896	36	M 50x1,5	16	33,50	130,9	50	79,8	10
EBF90-48-50	10106973	10106981	48	M 50x1,5	16	42,50	131,6	60	86	5
EBF90-48-63	10108890	10108897	48	M 63x1,5	17,5	44	140,9	60	90,2	5



BraceFITTING Wellrohrverschraubungen 90° Winkel, EMBF90, Kunststoff und Messing, metrisch



EMBF90

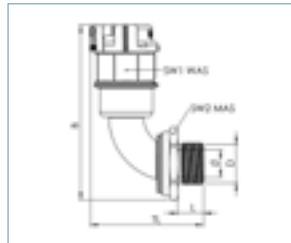

Schutzart IP68
Einsatztemperatur -40 °C - 100 °C
Material Verschraubung Polyamid UL94-V0, Anschlussgewinde Messing vernickelt, Dichtung TPU

Type	WISKA-No. RAL 7031 BG	WISKA-No. RAL 9005 BK	NW	D (mm)	l (mm)	VD (mm)	B (mm)	SW 1 (mm)	SW 2 (mm)	TL (mm)	
EMBF90-07-12	10107013	10106998	7	M 12x1,5	9	6	65,6	18	17	40,4	50
EMBF90-10-12	10107014	10106999	10	M 12x1,5	12	7	70,1	20	20	44	50
EMBF90-10-16	10107015	10107000	10	M 16x1,5	12	7	71,1	22	20	44	50
EMBF90-12-16	10107016	10107001	12	M 16x1,5	12	10	72,7	23	22	48,1	50
EMBF90-12-20	10107017	10107002	12	M 20x1,5	12	10	72,7	23	22	48,1	50
EMBF90-17-20	10107018	10107003	17	M 20x1,5	12	13	82	30	27	52	50
EMBF90-17-25	10107019	10107004	17	M 25x1,5	12	13	82	30	27	52	50
EMBF90-23-25	10107020	10107005	23	M 25x1,5	12	18	96,2	36	36	58,9	25
EMBF90-23-32	10107021	10107006	23	M 32x1,5	12	18	96,2	36	36	59,9	25
EMBF90-29-32	10107022	10107007	29	M 32x1,5	12	26	108,5	46	41	65,9	25
EMBF90-29-40	10107023	10107008	29	M 40x1,5	12	26	108,7	46	41	65,9	25
EMBF90-36-40	10107024	10107009	36	M 40x1,5	12	33	122,2	50	50	80,7	10
EMBF90-36-50	10107025	10107010	36	M 50x1,5	14	33	125	55	50	82,7	10
EMBF90-48-50	10107026	10107011	48	M 50x1,5	14	42	138,4	65	60	93,4	5
EMBF90-48-63	10107027	10107012	48	M 63x1,5	14	42	141,1	70	60	93,4	5



KABEL-VER-SCHRAU-BUNGEN
 KUNST-STOFF
 METALL
 MARTITIM
 ENV
 EX E/I
 EX D
 RAILWAY
 DRUCKKAUS-GLEICH / VENTING
 BRITISH STANDARD
 DICH-TUNGEN
 MEMBRAN-EINFÜH-RUNGEN
 MEMBRAN
 KABEL-EINFÜH-RUNGS-SYSTEM
 CONMAXX
 CONMAXX TEILB-VER-SCHRAU-BUNG
 KABEL-SCHUTZ
 BRACE FITTING KUNST-STOFF
 BRACE CONDUIT KUNST-STOFF
 BRACE FITTING METALL
 BRACE CONDUIT METALL
 BRACE SLEEVE

BraceFITTING Wellrohrverschraubungen 90° Winkel mit Innengewinde, EMBF90I, Kunststoff und Messing, metrisch

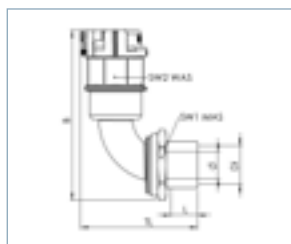

EMBF90I



Schutzart IP68
Einsatztemperatur -40 °C · 100 °C
Material Verschraubung Polyamid UL94-V0, Anschlussgewinde Messing vernickelt, Dichtung TPU

Type	WISKA-No. RAL 7031 BG	WISKA-No. RAL 9005 BK	NW	D (mm)	L (mm)	Ø	VD (mm)	SW 1 (mm)	SW 2 (mm)	TL (mm)	
EMBF90I-10-16	10107354	10107363	10	M 16x1,5	13	7	67,7	22	20	45,9	50
EMBF90I-12-16	10107355	10107364	12	M 16x1,5	13	10	72,9	24	22	54,1	50
EMBF90I-12-20	10107356	10107365	12	M 20x1,5	13	10	72,9	24	22	54,1	50
EMBF90I-17-20	10107357	10107366	17	M 20x1,5	13	13	79,6	30	27	59,4	50
EMBF90I-23-25	10107359	10107367	23	M 25x1,5	13	18	95,7	36	36	68,7	50
EMBF90I-29-32	10107360	10107368	29	M 32x1,5	13	26	111,7	46	41	74,5	25
EMBF90I-36-40	10107361	10107369	36	M 40x1,5	13	33	120,8	55	50	85,2	10
EMBF90I-48-50	10107362	10107370	48	M 50x1,5	14	42	136,3	65	60	109,6	10

Empfohlenes Zubehör



BraceFITTING Wellrohrverschraubungen 90° Winkel mit Kabelverschraubung, EMBF90CG, Kunststoff und Messing, metrisch

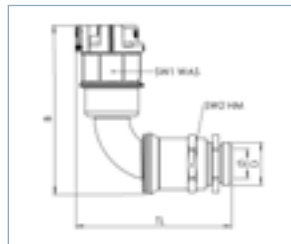

EMBF90CG

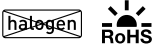

Schutzart IP68
Einsatztemperatur -40 °C · 100 °C
Material Verschraubung Polyamid UL94-V0, Anschlussgewinde Messing vernickelt, Dichtung TPU

Type	WISKA-No. RAL 7031 BG	WISKA-No. RAL 9005 BK	NW	D (mm)	t (mm)	VD (mm)	Ø	B (mm)	SW 1 (mm)	SW 2 (mm)	TL (mm)	
EMBF90CG-10-16	10107999	10108006	10	M 16x1,5	5	22,30	7	66,5	20	20	72,1 · 80,1	50
EMBF90CG-12-16	10108000	10108007	12	M 16x1,5	5	25	10	74	22	24	73,8 · 81,8	50
EMBF90CG-17-20	10108001	10108008	17	M 20x1,5	6	30,40	13	79,8	27	24	75,3 · 83,3	50
EMBF90CG-23-25	10108002	10108009	23	M 25x1,5	7	39,40	17	91,7	36	29	88,2 · 97,2	25
EMBF90CG-29-32	10108003	10108010	29	M 32x1,5	8	44,40	21	109	41	36	106,3 · 114,3	25
EMBF90CG-36-40	10108004	10108011	36	M 40x1,5	8	53,40	28	118,1	50	46	115,2 · 126,2	5
EMBF90CG-48-50	10108005	10108012	48	M 50x1,5	9	65,80	35	133,2	60	55	135,9 · 146,9	5



- KABEL-VER-SCHRAU-BUNGEN
- KUNST-STOFF
- METALL
- MARTITIM
- EMV
- EX E/I
- EX D
- RAILWAY
- BRÜCKEN-DRUCK-LEITUNG
- BRITISH STANDARD
- DICH-TUNGEN
- MEMBRAN-EINFÜH-RUNGEN
- MEMBRAN
- KABEL-EINFÜH-RUNGS-SYSTEM
- CONMAXX
- CONMAXX TEIL-VER-SCHRAU-BUNG
- KABEL-SCHUTZ
- BRACE FITTING KUNST-STOFF
- BRACE CONDUIT KUNST-STOFF
- BRACE FITTING METALL
- BRACE CONDUIT METALL
- BRACE SLEEVE

BraceCONDUIT Wellrohre, BCA-S, Kunststoff PA6 V0

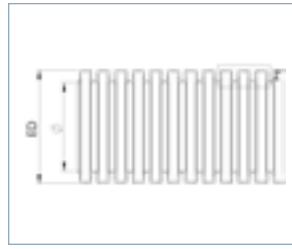

BCA-S



Einsatztemperatur -40 °C - 140 °C
Material PA6 UL94-V0

Type	WISKA-No. RAL 7031 BG	WISKA-No. RAL 9005 BK	NW	ED (mm)	∅	A	B (mm)	∠	S (mm)	VPE (m)
BCA-S-10	10107079	10107072	10	13	9,90	2,7	1,8	26	0,3	50
BCA-S-12	10107080	10107073	12	15,7	12,20	3,1	2,2	38	0,3	50
BCA-S-14	10107081	10107074	14	18,5	14,20	3,3	2,3	50	0,3	50
BCA-S-17	10107082	10107075	17	21,2	16,60	3,3	2,3	56	0,3	50
BCA-S-23	10107083	10107076	23	28,3	23,20	3,4	2,3	64	0,4	50
BCA-S-29	10107084	10107077	29	34,5	29	3,4	2,3	77	0,4	25
BCA-S-36	10107085	10107078	36	42,2	36	4,2	2,8	91	0,4	25

Empfohlenes Zubehör



BraceFITTING aus Kunststoff und
Kunststoff / Metall

BraceCONDUIT Wellrohre, BCAV-S, Kunststoff PA6 V2



BCAV-S

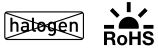
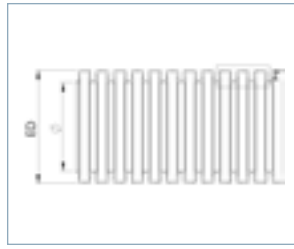

Einsatztemperatur -40 °C - 125 °C
Material PA6 UL94-V2

Type	WISKA-No. RAL 7031 BG	WISKA-No. RAL 9005 BK	NW	ED (mm)	Ø	A	B (mm)	90°	S (mm)	VPE (m)
BCAV-S-07	10107095	10107086	7	10	6,70	2,7	1,8	24	0,2	50
BCAV-S-10	10107096	10107087	10	13	9,90	2,7	1,8	26	0,2	50
BCAV-S-12	10107097	10107088	12	15,7	12,20	3,1	2,2	38	0,3	50
BCAV-S-14	10107098	10107089	14	18,5	14,20	3,3	2,3	50	0,3	50
BCAV-S-17	10107099	10107090	17	21,2	16,60	3,3	2,3	56	0,3	50
BCAV-S-23	10107100	10107091	23	28,3	23,20	3,4	2,3	64	0,4	50
BCAV-S-29	10107101	10107092	29	34,5	29	3,4	2,3	77	0,4	25
BCAV-S-36	10107102	10107093	36	42,4	36	4,2	2,8	91	0,4	25
BCAV-S-48	10107103	10107094	48	54,5	47,70	4,3	2,8	117	0,4	25

Empfohlenes Zubehör



BraceFITTING aus Kunststoff und Kunststoff / Metall

KABEL-VER-SCHRAUBUNGEN
KUNSTSTOFF
METALL
MARTITIM
ENV
EX E/I
EX D
RAILWAY
BRUCKAUS-GLEICH / VENTING
BRITISH STANDARD
DICHTUNGEN
MEMBRAN-EINFÜHRUNGEN
MEMBRAN
KABEL-EINFÜHRUNGSSYSTEM
CONMAXX
CONMAXX TEILB. VER-SCHRAUBUNG
KABEL-SCHUTZ
BRACE FITTING KUNSTSTOFF
BRACE CONDUIT KUNSTSTOFF
BRACE FITTING METALL
BRACE CONDUIT METALL
BRACE SLEEVE

BraceCONDUIT Wellrohre, BCIV-S, Kunststoff PA12 V2

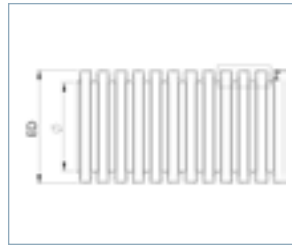

BCIV-S



Einsatztemperatur -40 °C - 110 °C
Material PA12 UL94-V2

Type	WISKA-No. RAL 7031 BG	WISKA-No. RAL 9005 BK	NW	ED (mm)	Ø	A	B (mm)	90°	S (mm)	VPE (m)
BCIV-S-10	10107112	10107104	10	13	9,80	2,7	1,8	21	0,2	50
BCIV-S-12	10107113	10107105	12	15,8	12	3,1	2,2	28	0,3	50
BCIV-S-14	10107114	10107106	14	18,5	14,20	3,3	2,9	34	0,3	50
BCIV-S-17	10107115	10107107	17	21	15,80	3,3	2,3	36	0,3	50
BCIV-S-23	10107116	10107108	23	28,5	22	3,4	3,4	49	0,4	50
BCIV-S-29	10107117	10107109	29	34,5	28,90	3,4	3,4	67	0,4	25
BCIV-S-36	10107118	10107110	36	42,3	36	4,2	2,8	81	0,4	25
BCIV-S-48	10107119	10107111	48	54,2	47,50	4,2	2,8	102	0,4	25

Empfohlenes Zubehör



BraceFITTING aus Kunststoff und Kunststoff / Metall

BraceCONDUIT Wellrohre, BCAB-L, Kunststoff PA 6 HB, leichte Ausführung



BCAB-L

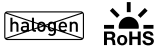
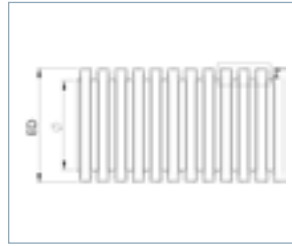

Einsatztemperatur -40 °C - 140 °C
Material PA6 UL94-HB

Type	WISKA-No. RAL 7031 BG	WISKA-No. RAL 9005 BK	NW	ED (mm)	Ø	A	B (mm)	W	S (mm)	VPE (m)
BCAB-L-07	10109190	10109181	7	10	6,80	2,7	1,8		0,2	50
BCAB-L-10	10109191	10109182	10	13	10	2,7	1,8	20	0,3	50
BCAB-L-12	10109192	10109183	12	15,7	12,40	3,1	2,2	25	0,3	50
BCAB-L-14	10109193	10109184	14	18,5	14,40	3,3	2,3		0,3	50
BCAB-L-17	10109194	10109185	17	21,2	16,80	3,3	2,3	50	0,3	50
BCAB-L-23	10109195	10109186	23	28,3	23,40	3,4	2,3	60	0,3	50
BCAB-L-29	10109196	10109187	29	34,5	29,20	3,4	2,3	70	0,4	50
BCAB-L-36	10109197	10109188	36	42,4	36,20	4,2	2,8	80	0,4	50
BCAB-L-48	10109198	10109189	48	54,5	47,90	4,3	2,8	95	0,4	50

Empfohlenes Zubehör



BraceFITTING aus Kunststoff und Kunststoff / Metall

KABEL-VER-SCHRAUBUNGEN
KUNSTSTOFF
METALL
MARTITIM
ENV
EX E/I
EX D
RAILWAY
BRUCKAUS-GLEICH / VENTING
BRITISH STANDARD
DICHTUNGEN
MEMBRAN-EINFÜHRUNGEN
MEMBRAN
KABEL-EINFÜHRUNGSSYSTEM
CONMAXX
CONMAXX TEILB. VER-SCHRAUBUNG
KABEL-SCHUTZ
BRACE FITTING KUNSTSTOFF
BRACE CONDUIT KUNSTSTOFF
BRACE FITTING METALL
BRACE CONDUIT METALL
BRACE SLEEVE

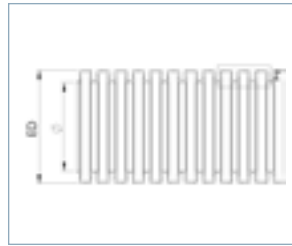

BraceCONDUIT Wellrohre, BCAV-H, Kunststoff PA 6 V2, schwere Ausführung



BCAV-H



Einsatztemperatur -40 °C - 125 °C
Material PA6 UL94-V2

Type	WISKA-No. RAL 7031 BG	WISKA-No. RAL 9005 BK	NW	ED (mm)	∅		B (mm)			VPE (m)
BCAV-H-07	10109207	10109199	7	10	6,40	2,7	1,8	23	0,4	50
BCAV-H-10	10109208	10109200	10	13	9	2,7	1,8	36	0,4	50
BCAV-H-12	10109209	10109201	12	15,8	11	3,1	2,2	48	0,4	50
BCAV-H-17	10109210	10109202	17	21	15,30	3,3	2,3	55	0,5	50
BCAV-H-23	10109211	10109203	23	28,5	21,60	3,4	2,3	65	0,5	50
BCAV-H-29	10109212	10109204	29	34,5	27,50	3,4	2,3	77	0,7	50
BCAV-H-36	10109213	10109205	36	42,5	35	4,2	2,8	96	0,7	50
BCAV-H-48	10109214	10109206	48	54,5	45,50	4,3	2,8	112	0,7	50

Empfohlenes Zubehör



BraceFITTING aus Kunststoff und
Kunststoff / Metall

BraceCONDUIT Wellrohre, BCIB-H, Kunststoff PA 12 HB, schwere Ausführung



BCIB-H

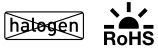
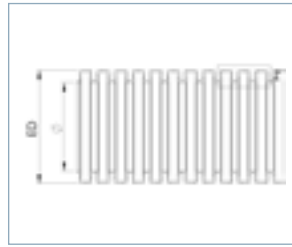

Einsatztemperatur -40 °C - 120 °C
Material PA12 UL94-HB

Type	WISKA-No. RAL 7031 BG	WISKA-No. RAL 9005 BK	NW	ED (mm)	Ø	A	B (mm)	W	S (mm)	VPE (m)
BCIB-H-07	10109229	10109220	7	10	6,80	2,7	1,8	15	0,2	50
BCIB-H-10	10109230	10109221	10	13	9,80	2,7	1,8	21	0,3	50
BCIB-H-12	10109231	10109222	12	15,8	12	3,1	2,2	28	0,3	50
BCIB-H-14	10109232	10109223	14	18,5	14,20	3,3	2,9	34	0,3	50
BCIB-H-17	10109233	10109224	17	21	16,80	3,3	2,3	36	0,3	50
BCIB-H-23	10109234	10109225	23	28,5	22,90	3,4	2,3	49	0,4	50
BCIB-H-29	10109235	10109226	29	34,5	28,90	3,4	3,4	67	0,4	25
BCIB-H-36	10109236	10109227	36	42,5	35,20	5,8	4,1	81	0,4	25
BCIB-H-48	10109237	10109228	48	54,5	46,50	4,3	4,1	102	0,4	25

Empfohlenes Zubehör



BraceFITTING aus Kunststoff und Kunststoff / Metall

KABEL-VER-SCHRAUBUNGEN
KUNSTSTOFF
METALL
MARTITIM
ENV
EX E/I
EX D
RAILWAY
BRUCKAUS-GLEICH / VENTING
BRITISH STANDARD
DICHTUNGEN
MEMBRAN-EINFÜHRUNGEN
MEMBRAN
KABEL-EINFÜHRUNGSSYSTEM
CONMAXX
CONMAXX TEILB. VER-SCHRAUBUNG
KABEL-SCHUTZ
BRACE FITTING KUNSTSTOFF
BRACE CONDUIT KUNSTSTOFF
BRACE FITTING METALL
BRACE CONDUIT METALL
BRACE SLEEVE

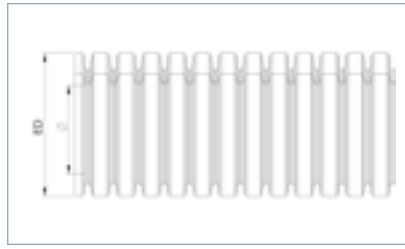

BraceCONDUIT Wellrohre geteilt, BCA-D, Kunststoff PA6 V0

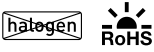

BCA-D



Einsatztemperatur -40 °C - 140 °C
Material PA6 UL94-V0

Type	WISKA-No. RAL 7031 BG	WISKA-No. RAL 9005 BK	NW	ED (mm)	Ø		B (mm)			VPE (m)
BCA-10-D	10107127	10107120	10	12,9	7,90	4	2,8	60	0,5	50
BCA-12-D	10107128	10107121	12	15,8	10,30	4	2,9	75	0,6	50
BCA-17-D	10107129	10107122	17	21	13,90	4,3	2,9	85	0,6	50
BCA-23-D	10107130	10107123	23	28,3	20,50	5,1	3,4	130	0,8	50
BCA-29-D	10107131	10107124	29	34,5	26,60	5,1	3,4	140	0,8	25
BCA-36-D	10107132	10107125	36	41,8	32	6,2	4	160	0,8	25
BCA-48-D	10107133	10107126	48	54,2	43	6,2	4	170	0,8	25

Empfohlenes Zubehör



BraceFITTING aus Kunststoff und
Kunststoff / Metall

BraceCONDUIT Wellrohre geteilt, BCAV-D, Kunststoff PA6 V2



BCAV-D

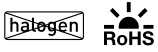
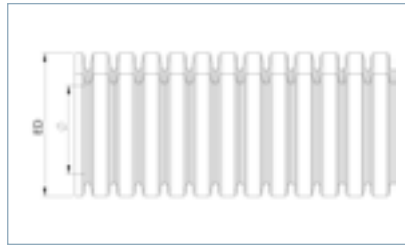

Einsatztemperatur -40 °C - 125 °C
Material PA6 UL94-V2

Type	WISKA-No. RAL 7031 BG	WISKA-No. RAL 9005 BK	NW	ED (mm)	Ø	A	B (mm)	90°	S (mm)	VPE (m)
BCAV-10-D	10107141	10107134	10	12,9	7,90	4	2,8	60	0,5	50
BCAV-12-D	10107142	10107135	12	15,8	10,30	4	2,9	75	0,6	50
BCAV-17-D	10107143	10107136	17	21	13,90	4,3	2,9	85	0,6	50
BCAV-23-D	10107144	10107137	23	28,3	20,50	5,1	3,4	130	0,8	50
BCAV-29-D	10107145	10107138	29	34,5	26,60	5,1	3,4	140	0,8	25
BCAV-36-D	10107146	10107139	36	41,8	32	6,2	4	160	0,8	25
BCAV-48-D	10107147	10107140	48	54,2	43	6,2	4	170	0,8	25

Empfohlenes Zubehör



BraceFITTING aus Kunststoff und Kunststoff / Metall

- KABEL-VER-SCHRAUBUNGEN
- KUNSTSTOFF
- METALL
- MARTITIM
- ENV
- EX E/ I
- EX D
- RAILWAY
- BRUCKAUSGLEICH / VENTING
- BRITISH STANDARD
- DICHTUNGEN
- MEMBRAN-EINFÜHRUNGEN
- MEMBRAN
- KABEL-EINFÜHRUNGSSYSTEM
- CONMAXX
- CONMAXX TEILB. VER-SCHRAUBUNG
- KABEL-SCHUTZ
- BRACE FITTING KUNSTSTOFF
- BRACE CONDUIT KUNSTSTOFF
- BRACE FITTING METALL
- BRACE CONDUIT METALL
- BRACE SLEEVE

BraceCONDUIT Wellrohrhalter, BCC, Kunststoff

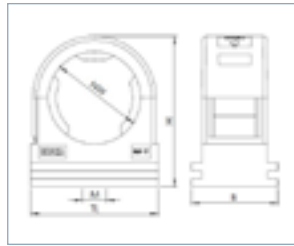

BCC



Einsatztemperatur -40 °C - 100 °C
Material Polyamid UL94-V0

Type	WISKA-No. RAL 7031 BG	WISKA-No. RAL 9005 BK	NW	B (mm)	H (mm)		TL (mm)	
BCC-07	10106930	10106939	7	20	22,5	M4	17	50
BCC-10	10106931	10106940	10	20	25	M5	22	50
BCC-12	10106932	10106941	12	20	29	M5	26	50
BCC-14	10106933	10106942	14	20	31,5	M5	27	50
BCC-17	10106934	10106943	17	20	34,8	M5	29,5	50
BCC-23	10106935	10106944	23	20	43,5	M6	39	25
BCC-29	10106936	10106945	29	20	49,5	M6	45	10
BCC-36	10106937	10106946	36	20	59	M6	54	10
BCC-48	10106938	10106947	48	20	74	M6	68	5

BraceFITTING Schutzschlauchverschraubungen, EMBMFS, Messing, metrisch



EMB MFS-S (glatt)



EMB MFS-C (wellrohrartig)

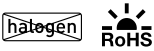
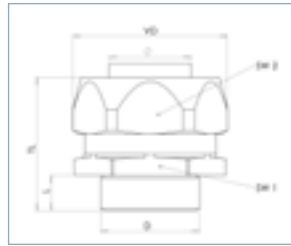

Schutzart IP67
Einsatztemperatur -15 °C - 70 °C
Material Verschraubung Messing vernickelt, Dichtung PA

Type	WISKA-No.	NW						VD (mm)	TL (mm)	Für Schutzschlauch	
EMB MFS-S-10-12	10109087	10	M 12x1,5	9	10	20	22	24	33,5	glatt	5
EMB MFS-S-10-16	10109089	10	M 16x1,5	9	10	20	22	24	33,5	glatt	5
EMB MFS-S-12-16	10109091	12	M 16x1,5	9	12	24	26	29	33,5	glatt	5
EMB MFS-S-12-20	10109093	12	M 20x1,5	9	12	24	26	29	33,5	glatt	5
EMB MFS-S-16-16	10109095	16	M 16x1,5	9	15,50	27	29	33	33,5	glatt	5
EMB MFS-S-16-20	10109097	16	M 20x1,5	9	15,50	27	29	33	33,5	glatt	5
EMB MFS-S-16-25	10109099	16	M 25x1,5	9	15,50	27	29	33	33,5	glatt	5
EMB MFS-S-21-20	10109101	21	M 20x1,5	9	20,50	33	35	33	36,2	glatt	5
EMB MFS-S-21-25	10109103	21	M 25x1,5	9	20,50	33	35	33	36,8	glatt	5
EMB MFS-S-27-25	10109105	27	M 25x1,5	11	26,50	43	45	49	46,4	glatt	5
EMB MFS-S-27-32	10109107	27	M 32x1,5	11	26,50	43	45	49	46,4	glatt	2
EMB MFS-S-27-40	10109109	27	M 40x1,5	11	26,50	43	45	49	46,2	glatt	2
EMB MFS-S-35-40	10109111	35	M 40x1,5	11	34,50	52	54	60	46,8	glatt	2
EMB MFS-S-40-40	10109113	40	M 40x1,5	14	39,50	60	62	69	52,3	glatt	2
EMB MFS-S-40-50	10109115	40	M 50x1,5	14	39,50	60	62	69	54,5	glatt	2
EMB MFS-S-50-50	10109117	50	M 50x1,5	14	50,50	74	77	84,50	56,9	glatt	2
EMB MFS-S-50-63	10109119	50	M 63x1,5	14	50,50	74	77	84,50	56,9	glatt	2

Type	WISKA-No.	NW						VD (mm)	TL (mm)	Für Schutzschlauch	
EMB MFS-C-10-12	10109088	10	M 12x1,5	9	10	20	22	24	33,5	wellrohrartig	5
EMB MFS-C-10-16	10109090	10	M 16x1,5	9	10	20	22	24	33,5	wellrohrartig	5
EMB MFS-C-12-16	10109092	12	M 16x1,5	9	12	24	26	29	33,5	wellrohrartig	5
EMB MFS-C-12-20	10109094	12	M 20x1,5	9	12	24	26	29	33,5	wellrohrartig	5
EMB MFS-C-16-16	10109096	16	M 16x1,5	9	15,50	27	29	33	33,5	wellrohrartig	5
EMB MFS-C-16-20	10109098	16	M 20x1,5	9	15,50	27	29	33	33,5	wellrohrartig	5
EMB MFS-C-16-25	10109100	16	M 25x1,5	9	15,50	27	29	33	33,5	wellrohrartig	5
EMB MFS-C-21-20	10109102	21	M 20x1,5	9	20,50	33	35	33	36,2	wellrohrartig	5
EMB MFS-C-21-25	10109104	21	M 25x1,5	9	20,50	33	35	33	36,8	wellrohrartig	5
EMB MFS-C-21-25	10109106	27	M 25x1,5	11	26,50	43	45	49	46,4	wellrohrartig	5
EMB MFS-C-27-32	10109108	27	M 32x1,5	11	26,50	43	45	49	46,4	wellrohrartig	2
EMB MFS-C-27-40	10109110	27	M 40x1,5	11	26,50	43	45	49	46,2	wellrohrartig	2
EMB MFS-C-35-40	10109112	35	M 40x1,5	11	34,50	52	54	60	46,8	wellrohrartig	2
EMB MFS-C-40-40	10109114	40	M 40x1,5	14	39,50	60	62	69	52,3	wellrohrartig	2
EMB MFS-C-40-50	10109116	40	M 50x1,5	14	39,50	60	62	69	54,5	wellrohrartig	2
EMB MFS-C-50-50	10109118	50	M 50x1,5	14	50,50	74	77	84,50	56,9	wellrohrartig	2
EMB MFS-C-50-63	10109120	50	M 63x1,5	14	50,50	74	77	84,50	56,9	wellrohrartig	2

Empfohlenes Zubehör

BraceCONDUIT aus Metall glatt und wellrohrartig

KABEL-VER-SCHRAUBUNGEN
 KUNST-STOFF
 METALL
 MARTITIM
 EMV
 EX E/I
 EX D
 RAILWAY
 DRUCKAUS-GLEICH / VENTING
 BRITISH STANDARD
 DICH-TUNGEN
 MEMBRAN-EINFÜH-RUNGEN
 MEMBRAN
 KABEL-EINFÜH-RUNGS-SYSTEM
 CONMAXX
 CONMAXX TEILB. VER-SCHRAUBUNG
 KABEL-SCHUTZ
 BRACE FITTING KUNST-STOFF
 BRACE CONDUIT KUNST-STOFF
 BRACE FITTING METALL
 BRACE CONDUIT METALL
 BRACE SLEEVE

BraceCONDUIT Schutzschläuche wellrohrartig, BMCG-PVC-C, Stahl verzinkt, PVC ummantelt



BMCG-PVC-C-BK



BMCG-PVC-C-LG



Einsatztemperatur -15 °C - 70 °C
Material Stahl verzinkt, Rohrummantelung PVC, Oberfläche wellrohrartig

Type	WISKA-No. RAL 7035 LG	WISKA-No. RAL 9005 BK	NW	ED (mm)	∅		VPE (m)
BMCG-PVC-C-10	10109015	10109007	10	13,5	10	40	30
BMCG-PVC-C-12	10109016	10109008	12	15,7	12	50	30
BMCG-PVC-C-16	10109017	10109009	16	19,5	15,50	55	30
BMCG-PVC-C-21	10109018	10109010	21	24,7	20,50	60	30
BMCG-PVC-C-27	10109019	10109011	27	31,7	26,50	85	30
BMCG-PVC-C-35	10109020	10109012	35	40	34,50	120	30
BMCG-PVC-C-40	10109021	10109013	40	45	39,50	160	25
BMCG-PVC-C-50	10109022	10109014	50	56	50,50	200	25

Empfohlenes Zubehör



EMBMFS-C

KABEL-
VER-
SCRAU-
BUNGEN

KUNST-
STOFF

METALL

MARTIN

EMV

EX E/I

EX D

RAILWAY

DRUCKAUS-
GLEICH /
VENTING

BRITISH
STANDARD

DICH-
TUNGEN

MEMBRAN-
EINFÜH-
RUNGEN

MEMBRAN

KABEL-
EINFÜH-
RUNGS-
SYSTEM

CONMAXX

CONMAXX
TEIL-VER-
SCHRAU-
BUNG

KABEL-
SCHUTZ

BRACE
FITTING
KUNST-
STOFF

BRACE
CONDUIT
KUNST-
STOFF

BRACE
FITTING
METALL

BRACE
CONDUIT
METALL

BRACE
SLEEVE

BraceCONDUIT Schutzschläuche glatt, BMCG-PVC-S, Stahl verzinkt, PVC ummantelt



BMCG-PVC-S-BK



BMCG-PVC-S-LG

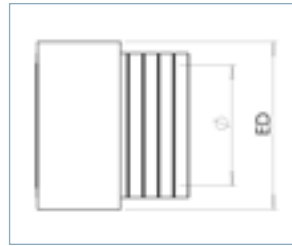

Einsatztemperatur
Material

-15 °C - 70 °C

Stahl verzinkt, Rohrummantelung PVC, Oberfläche glatt

Type	WISKA-No. RAL 7035 LG	WISKA-No. RAL 9005 BK	NW	ED (mm)	∅		VPE (m)
BMCG-PVC-S-10	10109031	10109023	10	15,5	10	50	30
BMCG-PVC-S-12	10109032	10109024	12	18	12	60	30
BMCG-PVC-S-16	10109033	10109025	16	21,5	15,50	70	30
BMCG-PVC-S-21	10109034	10109026	21	27	20,50	90	30
BMCG-PVC-S-27	10109035	10109027	27	33	26,50	120	30
BMCG-PVC-S-35	10109036	10109028	35	43	34,50	150	30
BMCG-PVC-S-40	10109037	10109029	40	48	39,50	200	25
BMCG-PVC-S-50	10109038	10109030	50	56	50,50	200	25

Empfohlenes Zubehör



EMBMFS-S

KABEL-VER-SCHRAUBUNGEN
KUNST-STOFF
METALL
MARTITIM
ENV
EX E/I
EX D
RAILWAY
BRÜCKAUSGLEICH / VENTING
BRITISH STANDARD
DICHTUNGEN
MEMBRAN-EINFÜHRUNGEN
MEMBRAN
KABEL-EINFÜHRUNGSSYSTEM
CONMAXX
CONMAXX TEILB. VER-SCHRAUBUNG
KABEL-SCHUTZ
BRACE FITTING KUNST-STOFF
BRACE CONDUIT KUNST-STOFF
BRACE FITTING METALL
BRACE CONDUIT METALL
BRACE SLEEVE

BraceCONDUIT Schutzschläuche glatt mit größerem Temperaturbereich, BMCG-PVC-S-GT, Stahl verzinkt, PVC ummantelt



BMCG-PVC-S-BK



BMCG-PVC-S-LG

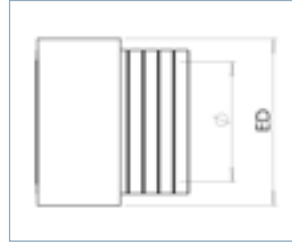

Einsatztemperatur -40 °C - 105 °C
Material Stahl verzinkt, Rohrummantelung PVC, Oberfläche glatt

Type	WISKA-No. RAL 7035 LG	WISKA-No. RAL 9005 BK	NW	ED (mm)	Ø		VPE (m)
BMCG-PVC-S-10-GT	10109047	10109039	10	15,5	10	50	30
BMCG-PVC-S-12-GT	10109048	10109040	12	18	12	60	30
BMCG-PVC-S-16-GT	10109049	10109041	16	21,5	15,50	70	30
BMCG-PVC-S-21-GT	10109050	10109042	21	27	20,50	90	30
BMCG-PVC-S-27-GT	10109051	10109043	27	33	26,50	120	30
BMCG-PVC-S-35-GT	10109052	10109044	35	43	34,50	150	30
BMCG-PVC-S-40-GT	10109053	10109045	40	48	39,50	200	25
BMCG-PVC-S-50-GT	10109054	10109046	50	56	50,50	200	25

Empfohlenes Zubehör



BraceCONDUIT Schutzschläuche wellrohrartig, BMCG-PU-C, Stahl verzinkt, PU ummantelt



BMCG-PU-C-BK



BMCG-PU-C-LG

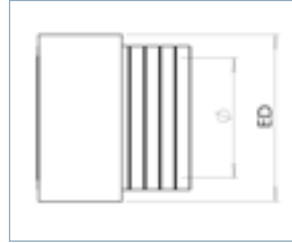

Einsatztemperatur -45 °C - 120 °C
Material Stahl verzinkt, Rohrummantelung PU, Oberfläche wellrohrartig

Type	WISKA-No. RAL 7035 LG	WISKA-No. RAL 9005 BK	WISKA No. blau	NW	ED (mm)	∅		VPE (m)
BMCG-PU-C-10	10109071	10109055	10109063	10	13,5	10	40	30
BMCG-PU-C-12	10109072	10109056	10109064	12	15,7	12	50	30
BMCG-PU-C-16	10109073	10109057	10109065	16	19,5	15,50	55	30
BMCG-PU-C-21	10109074	10109058	10109066	21	24,7	20,50	60	30
BMCG-PU-C-27	10109075	10109059	10109067	27	31,7	26,50	85	30
BMCG-PU-C-35	10109076	10109060	10109068	35	40	34,50	120	30
BMCG-PU-C-40	10109077	10109061	10109069	40	45	39,50	160	25
BMCG-PU-C-50	10109078	10109062	10109070	50	56	50,50	200	25

Empfohlenes Zubehör



EMBMFS-C

- KABEL-VER-SCHRAUBUNGEN
- KUNST-STOFF
- METALL
- MARTIM
- EMV
- EX E/I
- EX D
- RAILWAY
- BRUCKAUS-GLEICH / VENTING
- BRITISH STANDARD
- DICH-TUNGEN
- MEMBRAN-EINFÜHRUNGEN
- KABEL-EINFÜHRUNGS-SYSTEM
- CONMAXX
- CONMAXX TEILB-VER-SCHRAUBUNG
- KABEL-SCHUTZ
- BRACE FITTING KUNST-STOFF
- BRACE CONDUIT KUNST-STOFF
- BRACE FITTING METALL
- BRACE CONDUIT METALL
- BRACE SLEEVE

BraceCONDUIT Schutzschläuche, BMCG-PVC-C-BG, Stahl verzinkt, PVC und verzinktes Stahlgeflecht ummantelt



BMCG-PVC-C BG



BMCG-PVC-C BG

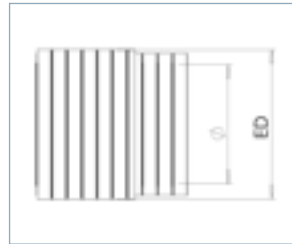

Schutzart IP67
Einsatztemperatur -15 °C - 70 °C
Material Stahl verzinkt, Rohrummantelung galvanisierter Stahl, Oberfläche wellrohrartig

Type	WISKA-No.	NW	ED (mm)	Ø		VPE (m)
BMCG-PVC-C-BG-10	10109079	10	15	10	40	30
BMCG-PVC-C-BG-12	10109080	12	17,5	12	50	30
BMCG-PVC-C-BG-16	10109081	16	21	15,50	55	30
BMCG-PVC-C-BG-21	10109082	21	26,5	20,50	60	30
BMCG-PVC-C-BG-27	10109083	27	32,5	26,50	85	30
BMCG-PVC-C-BG-35	10109084	35	42,5	34,50	120	30
BMCG-PVC-C-BG-40	10109085	40	47,5	39,50	160	25
BMCG-PVC-C-BG-50	10109086	50	59	50,50	200	25



KABEL-VER-SCRAUBUNGEN
 KUNSTSTOFF
 METALL
 MARTIN
 EMV
 EX E/I
 EX D
 RAILWAY
 DRUCKAUSGLEICH / VENTING
 BRITISH STANDARD
 DICHTUNGEN
 MEMBRAN-EINFÜHRUNGEN
 MEMBRAN
 KABEL-EINFÜHRUNGSSYSTEM
 CONNMAXX
 CONNMAXX TEIL-VERSCRAUBUNG
 KABELSCHUTZ
 BRACE FITTING KUNSTSTOFF
 BRACE CONDUIT KUNSTSTOFF
 BRACE FITTING METALL
 BRACE CONDUIT METALL
 BRACE SLEEVE



BraceCONDUIT Schutzschlauchhalter, BMCC, Stahl verzinkt



BMCC



Einsatztemperatur -40 °C - 100 °C
Material Stahl verzinkt

Type	WISKA-No.		
BMCC-13-17	10109251	8,5	10
BMCC-17-21	10109252	8,5	10
BMCC-21-26	10109253	8,5	10
BMCC-28-34	10109254	8,5	10
BMCC-37-44	10109255	10,5	10
BMCC-48-55	10109256	10,5	10

- KABEL-VER-SCHRAU-BUNGEN
- KUNST-STOFF
- METALL
- MARTIM
- ENV
- EX E/I
- EX D
- RAILWAY
- BRUCKAUS-GLEICH / VENTING
- BRITISH STANDARD
- DICH-TUNGEN
- MEMBRAN-EINFÜH-RUNGEN
- MEMBRAN
- KABEL-EINFÜH-RUNGS-SYSTEM
- CONMAXX
- CONMAXX-TEILB-VER-SCHRAU-BUNG
- KABEL-SCHUTZ
- BRACE FITTING KUNST-STOFF
- BRACE CONDUIT KUNST-STOFF
- BRACE FITTING METALL
- BRACE CONDUIT METALL
- BRACE SLEEVE

BraceSLEEVE Geflechtsschläuche, FP, Polyester, Monofilament



FP-BK



Einsatztemperatur -70 °C - 150 °C
Material Polyester UL94-V0
Hinweis Sehr gute Abriebbeständigkeit
 Hohe thermische Beständigkeit
 Selbstverlöschend
 IEC 60684, UL 224

Type	WISKA-No.	Farbe	ED (mm)	VPE (m)
FP-BK-04	10107156	schwarz	7	200
FP-BK-06	10107158	schwarz	10	200
FP-BK-08	10107159	schwarz	14	200
FP-BK-10	10107160	schwarz	18	200
FP-BK-12	10107161	schwarz	21	200
FP-BK-15	10107162	schwarz	22	200
FP-BK-20	10107163	schwarz	27	200
FP-BK-25	10107164	schwarz	34	100
FP-BK-30	10107165	schwarz	45	100
FP-BK-40	10107166	schwarz	60	50
FP-BK-50	10107167	schwarz	73	50
FP-LG-04	10107168	grau	7	200
FP-LG-06	10107169	grau	10	200
FP-LG-08	10107170	grau	14	200
FP-LG-10	10107171	grau	18	200
FP-LG-12	10107172	grau	21	200
FP-LG-15	10107173	grau	22	200
FP-LG-20	10107174	grau	27	200
FP-LG-25	10107175	grau	34	100
FP-LG-30	10107176	grau	45	100
FP-LG-40	10107177	grau	60	50
FP-LG-50	10107178	grau	73	50

BraceSLEEVE Gewebesläuche offen / selbstverschließend, PEOS, Polyester, Monofilament mit feuerresistenten Fasern



PEOS-BK



- Einsatztemperatur** -70 °C - 150 °C
- Material** Polyester UL94-V0
- Hinweis** Recyclebar
- Extra flexibel
- Sehr gute Abriebbeständigkeit
- Sehr hohe Verschlusskraft
- Selbstverlöschend
- IEC 60684, UL 224

Type	WISKA-No.	Farbe	ED (mm)	VPE (m)
PEOS-BK-030	10107179	schwarz	6	250
PEOS-BK-060	10107180	schwarz	10	200
PEOS-BK-090	10107181	schwarz	12	175
PEOS-BK-140	10107182	schwarz	21	100
PEOS-BK-200	10107183	schwarz	28	75
PEOS-BK-260	10107184	schwarz	34	75
PEOS-BK-320	10107185	schwarz	44	50
PEOS-BK-440	10107186	schwarz	61	35

- KABEL-VER-SCHRAUBUNGEN
- KUNST-STOFF
- METALL
- MARTIM
- EMV
- EX E/I
- EX D
- RAILWAY
- DRUCKAUSGLEICH / VENTING
- BRITISH STANDARD
- DICH-TUNGEN
- MEMBRAN-EINFÜHRUNGEN
- MEMBRAN
- KABEL-EINFÜHRUNGS-SYSTEM
- CONMAXX
- CONMAXX TEILB-VER-SCHRAUBUNG
- KABEL-SCHUTZ
- BRACE FITTING KUNST-STOFF
- BRACE CONDUIT KUNST-STOFF
- BRACE FITTING METALL
- BRACE CONDUIT METALL
- BRACE SLEEVE

BraceSLEEVE Geflechtsschläuche, FGB-SC-2,5, Glasfaser mit Spezial-Silikonkautschukmantel



FGB-SC-25-BK



Einsatztemperatur -70 °C - 235 °C
Material Glasfaser, Silikonkautschuk
Hinweis Selbstverlöschend
 Flexibel
 Ausgezeichnete Beständigkeit gegen Öl, Flüssigkeiten und aggressive chemische Stoffe
 Schutz vor Durchschlagsspannung von 2,5 kV bis 4 kV
 IEC 60684

Type	WISKA-No.	Farbe	Ø	VPE (m)
FGB-SC-25-BK-005	10107195	schwarz	0,50	400
FGB-SC-25-BK-010	10107196	schwarz	1	400
FGB-SC-25-BK-015	10107197	schwarz	1,50	200
FGB-SC-25-BK-020	10107198	schwarz	2	200
FGB-SC-25-BK-025	10107199	schwarz	2,50	200
FGB-SC-25-BK-030	10107200	schwarz	3	200
FGB-SC-25-BK-035	10107201	schwarz	3,50	200
FGB-SC-25-BK-040	10107202	schwarz	4	200
FGB-SC-25-BK-045	10107203	schwarz	4,50	200
FGB-SC-25-BK-050	10107204	schwarz	5	200
FGB-SC-25-BK-060	10107205	schwarz	6	200
FGB-SC-25-BK-070	10107206	schwarz	7	200
FGB-SC-25-BK-080	10107207	schwarz	8	100
FGB-SC-25-BK-090	10107208	schwarz	9	100
FGB-SC-25-BK-100	10107209	schwarz	10	100
FGB-SC-25-BK-120	10107210	schwarz	12	100
FGB-SC-25-BK-140	10107211	schwarz	14	100
FGB-SC-25-BK-160	10107212	schwarz	16	50
FGB-SC-25-BK-180	10107213	schwarz	18	50
FGB-SC-25-BK-200	10107214	schwarz	20	50
FGB-SC-25-BK-250	10107215	schwarz	25	50
FGB-SC-25-RB-005	10107216	rotbraun	0,50	400
FGB-SC-25-RB-010	10107217	rotbraun	1	400
FGB-SC-25-RB-015	10107218	rotbraun	1,50	200
FGB-SC-25-RB-020	10107219	rotbraun	2	200
FGB-SC-25-RB-025	10107220	rotbraun	2,50	200
FGB-SC-25-RB-030	10107221	rotbraun	3	200
FGB-SC-25-RB-035	10107222	rotbraun	3,50	200
FGB-SC-25-RB-040	10107223	rotbraun	4	200
FGB-SC-25-RB-045	10107224	rotbraun	4,50	200
FGB-SC-25-RB-050	10107225	rotbraun	5	200
FGB-SC-25-RB-060	10107226	rotbraun	6	200
FGB-SC-25-RB-070	10107227	rotbraun	7	200
FGB-SC-25-RB-080	10107228	rotbraun	8	100
FGB-SC-25-RB-090	10107229	rotbraun	9	100
FGB-SC-25-RB-100	10107230	rotbraun	10	100
FGB-SC-25-RB-120	10107231	rotbraun	12	100
FGB-SC-25-RB-140	10107232	rotbraun	14	100
FGB-SC-25-RB-160	10107233	rotbraun	16	50
FGB-SC-25-RB-180	10107234	rotbraun	18	50
FGB-SC-25-RB-200	10107235	rotbraun	20	50
FGB-SC-25-RB-250	10107236	rotbraun	25	50

BraceSLEEVE Geflechtsschläuche feuerresistent, FGB-SC-7,5, Glasfaser mit Spezial-Silikonkautschukmantel



FGB-SC-75-BK

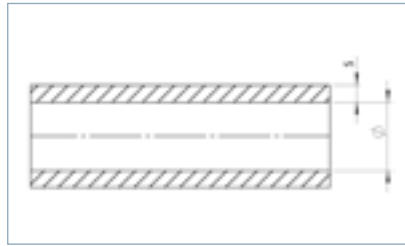

Einsatztemperatur -70 °C - 235 °C

Material Glasfaser, Silikonkautschuk

Hinweis Selbstverlöschend

Feuerresistent

Flexibel

Ausgezeichnete Beständigkeit gegen Öl, Flüssigkeiten und aggressive chemische Stoffe

Schutz vor Durchschlagsspannung bis 7,5 kV

IEC 60684, UL 1441

Type	WISKA-No.	Farbe	∅	VPE (m)
FGB-SC-75-BK-005	10107237	schwarz	0,50	200
FGB-SC-75-BK-010	10107238	schwarz	1	200
FGB-SC-75-BK-020	10107239	schwarz	2	200
FGB-SC-75-BK-025	10107240	schwarz	2,50	200
FGB-SC-75-BK-030	10107241	schwarz	3	200
FGB-SC-75-BK-040	10107242	schwarz	4	200
FGB-SC-75-BK-050	10107243	schwarz	5	100
FGB-SC-75-BK-070	10107244	schwarz	7	100
FGB-SC-75-BK-080	10107245	schwarz	8	100
FGB-SC-75-BK-100	10107246	schwarz	10	100
FGB-SC-75-BK-120	10107247	schwarz	12	50
FGB-SC-75-BK-140	10107248	schwarz	14	50
FGB-SC-75-BK-180	10107249	schwarz	18	50
FGB-SC-75-BK-200	10107250	schwarz	20	50
FGB-SC-75-BK-220	10107251	schwarz	22	50
FGB-SC-75-BK-250	10107252	schwarz	25	50
FGB-SC-75-LG-005	10107253	schwarz	0,50	200
FGB-SC-75-RB-010	10107254	rotbraun	1	200
FGB-SC-75-RB-020	10107255	rotbraun	2	200
FGB-SC-75-RB-025	10107256	rotbraun	2,50	200
FGB-SC-75-RB-030	10107257	rotbraun	3	200
FGB-SC-75-RB-040	10107258	rotbraun	4	200
FGB-SC-75-RB-050	10107259	rotbraun	5	100
FGB-SC-75-RB-070	10107260	rotbraun	7	100
FGB-SC-75-RB-080	10107261	rotbraun	8	100
FGB-SC-75-RB-100	10107262	rotbraun	10	100
FGB-SC-75-RB-120	10107263	rotbraun	12	50
FGB-SC-75-RB-140	10107264	rotbraun	14	50
FGB-SC-75-RB-180	10107265	rotbraun	18	50
FGB-SC-75-RB-200	10107266	rotbraun	20	50
FGB-SC-75-RB-220	10107267	rotbraun	22	50
FGB-SC-75-RB-250	10107268	rotbraun	25	50

KABEL-
VER-
SCHRAU-
BUNGEN

KUNST-
STOFF

METALL

MARTITIM

EMV

EX E/I

EX D

RAILWAY

DRUCKKAUS-
GLEICH /
VENTING

BRITISH
STANDARD

DICH-
TUNGEN

MEMBRAN-
EINFÜH-
RUNGEN

MEMBRAN

KABEL-
EINFÜH-
RUNGS-
SYSTEM

CONMAXX

CONMAXX
TEILB. VER-
SCHRAU-
BUNG

KABEL-
SCHUTZ

BRACE
FITTING
KUNST-
STOFF

BRACE
CONDUIT
KUNST-
STOFF

BRACE
FITTING
METALL

BRACE
CONDUIT
METALL

BRACE
SLEEVE

BraceSLEEVE Geflechtsschläuche feuerresistent, FGB-SCE, Glasfaser mit dickwandigem Spezial-Silikonkautschukmantel



FGB-SCE-RD



Einsatztemperatur -70 °C - 235 °C

Material Glasfaser, Silikonkautschuk

Hinweis Hohe thermische Isolierung; selbstverlöschend

Feuerresistent

Flexibel

Ausgezeichnete Beständigkeit gegen Öle, Flüssigkeiten und aggressive chemische Stoffe

Type	WISKA-No.	Farbe	ED (mm)	VPE (m)
FGB-SCE-RD-040	10107269	rot	4	90
FGB-SCE-RD-060	10107270	rot	6	30
FGB-SCE-RD-080	10107271	rot	8	30
FGB-SCE-RD-100	10107272	rot	10	30
FGB-SCE-RD-120	10107273	rot	12	30
FGB-SCE-RD-140	10107274	rot	14	50
FGB-SCE-RD-160	10107275	rot	16	50
FGB-SCE-RD-180	10107276	rot	18	50
FGB-SCE-RD-200	10107277	rot	20	25
FGB-SCE-RD-220	10107278	rot	22	25
FGB-SCE-RD-250	10107279	rot	25	25
FGB-SCE-RD-300	10107280	rot	30	25
FGB-SCE-RD-350	10107281	rot	35	25
FGB-SCE-RD-400	10107282	rot	40	20
FGB-SCE-RD-450	10107283	rot	45	15
FGB-SCE-RD-500	10107284	rot	50	15
FGB-SCE-RD-550	10107285	rot	55	15
FGB-SCE-RD-600	10107286	rot	60	15

BraceSLEEVE Geflechtsschläuche, FGB-SVI, Glasfaser mit Silikonlack



FGB-SVI-LG



Einsatztemperatur	-70 °C - 300 °C
Material	Glasfaser, Silikonkautschuk
Hinweis	Hochflexibel, selbstverlöschend Hohe Widerstandsfähigkeit Gute Abriebbeständigkeit Elektrischer Isolationsschutz IEC 60684, UL 1441

Type	WISKA-No.	Farbe	Ø	VPE (m)
FGB-SVI-BK-005	10107287	schwarz	0,50	400
FGB-SVI-BK-010	10107288	schwarz	1	300
FGB-SVI-BK-030	10107289	schwarz	3	300
FGB-SVI-BK-035	10107290	schwarz	3,50	300
FGB-SVI-BK-040	10107291	schwarz	4	300
FGB-SVI-BK-050	10107292	schwarz	5	200
FGB-SVI-BK-060	10107293	schwarz	6	200
FGB-SVI-BK-080	10107294	schwarz	8	200
FGB-SVI-BK-100	10107295	schwarz	10	200
FGB-SVI-BK-120	10107296	schwarz	12	100
FGB-SVI-BK-140	10107297	schwarz	14	100
FGB-SVI-BK-160	10107298	schwarz	16	100
FGB-SVI-BK-180	10107299	schwarz	18	100
FGB-SVI-BK-200	10107300	schwarz	20	100
FGB-SVI-BK-250	10107301	schwarz	25	50
FGB-SVI-WH-005	10107302	weiß	0,50	400
FGB-SVI-WH-010	10107303	weiß	1	300
FGB-SVI-WH-030	10107304	weiß	3	300
FGB-SVI-WH-035	10107305	weiß	3,50	300
FGB-SVI-WH-040	10107306	weiß	4	300
FGB-SVI-WH-050	10107307	weiß	5	200
FGB-SVI-WH-060	10107308	weiß	6	200
FGB-SVI-WH-080	10107309	weiß	8	200
FGB-SVI-WH-100	10107310	weiß	10	200
FGB-SVI-WH-120	10107311	weiß	12	100
FGB-SVI-WH-140	10107312	weiß	14	100
FGB-SVI-WH-160	10107313	weiß	16	100
FGB-SVI-WH-180	10107314	weiß	18	100
FGB-SVI-WH-200	10107315	weiß	20	100
FGB-SVI-WH-250	10107316	weiß	25	50

KABEL-VER-SCHRAUBUNGEN
KUNST-STOFF
METALL
MARTIM
EMV
EX E/I
EX D
RAILWAY
DRUCKAUSGLEICH / VENTING
BRITISH STANDARD
DICHTUNGEN
MEMBRAN-EINFÜHRUNGEN
MEMBRAN
KABEL-EINFÜHRUNGSSYSTEM
CONMAXX
CONMAXX TEILVER-SCHRAUBUNG
KABEL-SCHUTZ
BRACE FITTING KUNSTSTOFF
BRACE CONDUIT KUNSTSTOFF
BRACE FITTING METALL
BRACE CONDUIT METALL
BRACE SLEEVE

BraceSLEEVE Geflechtsschläuche offen / selbstverschließend und feuerresistent, FGBOS-SC, Glasfaser / Polyester mit Spezial-Silikonmantel



FGBOS-RD



Einsatztemperatur -70 °C - 200 °C
Material Glasfaser / Polyester, Silikon
Hinweis Flexibel, Hitzeschutz, feuerfest, selbstverlöschend; Hervorragende Beständigkeit gegenüber Ölen, Flüssigkeiten und aggressiven Chemikalien; UL 1441

Type	WISKA-No.	Farbe	VPE (m)
FGBOS-SC-RD-080	10108639	rot	400
FGBOS-SC-RD-120	10108640	rot	300
FGBOS-SC-RD-160	10108641	rot	300
FGBOS-SC-RD-200	10108642	rot	300
FGBOS-SC-RD-250	10108643	rot	300
FGBOS-SC-RD-320	10108644	rot	200
FGBOS-SC-RD-450	10108645	rot	200
FGBOS-RD-600	10108646	rot	200

BraceSLEEVE EMV Gewebesläuche offen / selbstverschließend, PSOS-GD, Polyphenylensulfid (PPS), Monofilament

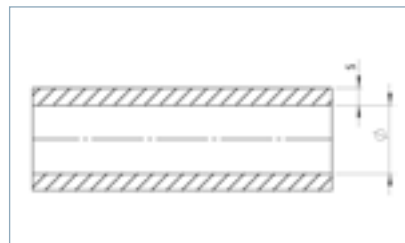

PSOS-GD



Einsatztemperatur -65 °C - 200 °C
Material Polyphenylensulfid, Kupfergarn vernickelt
Hinweis Hochflexibel, Halogenfrei, Selbstverlöschend; Hohe Widerstandsfähigkeit; Gute Abriebbeständigkeit; EMV-Schutz; EN 4674-001/ 002/ 003

Type	WISKA-No.	Farbe	VPE (m)
PSOS-GD-005-EMV	10108647	golden	250
PSOS-GD-008-EMV	10108648	golden	250
PSOS-GD-013-EMV	10108649	golden	250
PSOS-GD-016-EMV	10108650	golden	250
PSOS-GD-019-EMV	10108651	golden	250
PSOS-GD-025-EMV	10108652	golden	250
PSOS-GD-032-EMV	10108653	golden	250
PSOS-GD-038-EMV	10108654	golden	250
PSOS-GD-045-EMV	10108655	golden	250

Unser WISKA-Programm



Kabeleinführungen

Kabelverschraubungen
Membraneinführungen
Kabeleinführungssysteme
Kabelschutz



Installationsmaterial

Abzweig- und Feuchtraumkästen für Innen und Außen
Gel-Muffen
Verbindungsmuffen



Maritimes Installationsmaterial

Installationsmaterial aus Kunststoff, Aluminium, Messing und Edelstahl

- HNA-Material
- Abzweiggästen, Schalter, Steckdosen

EX Abzweiggästen, EX Schalter, EX Steckdosen

Kühlcontainer-Steckdosen, CEE Material



Beleuchtung

LED Strahler und Leuchten
Vielzweckleuchten
EX Leuchten
Suchscheinwerfer



CCTV: Maritime Kameraüberwachung

Netzwerkcameras
EX Kameras
Domkameras
Scheinwerfer-Kamera-Kombinationen

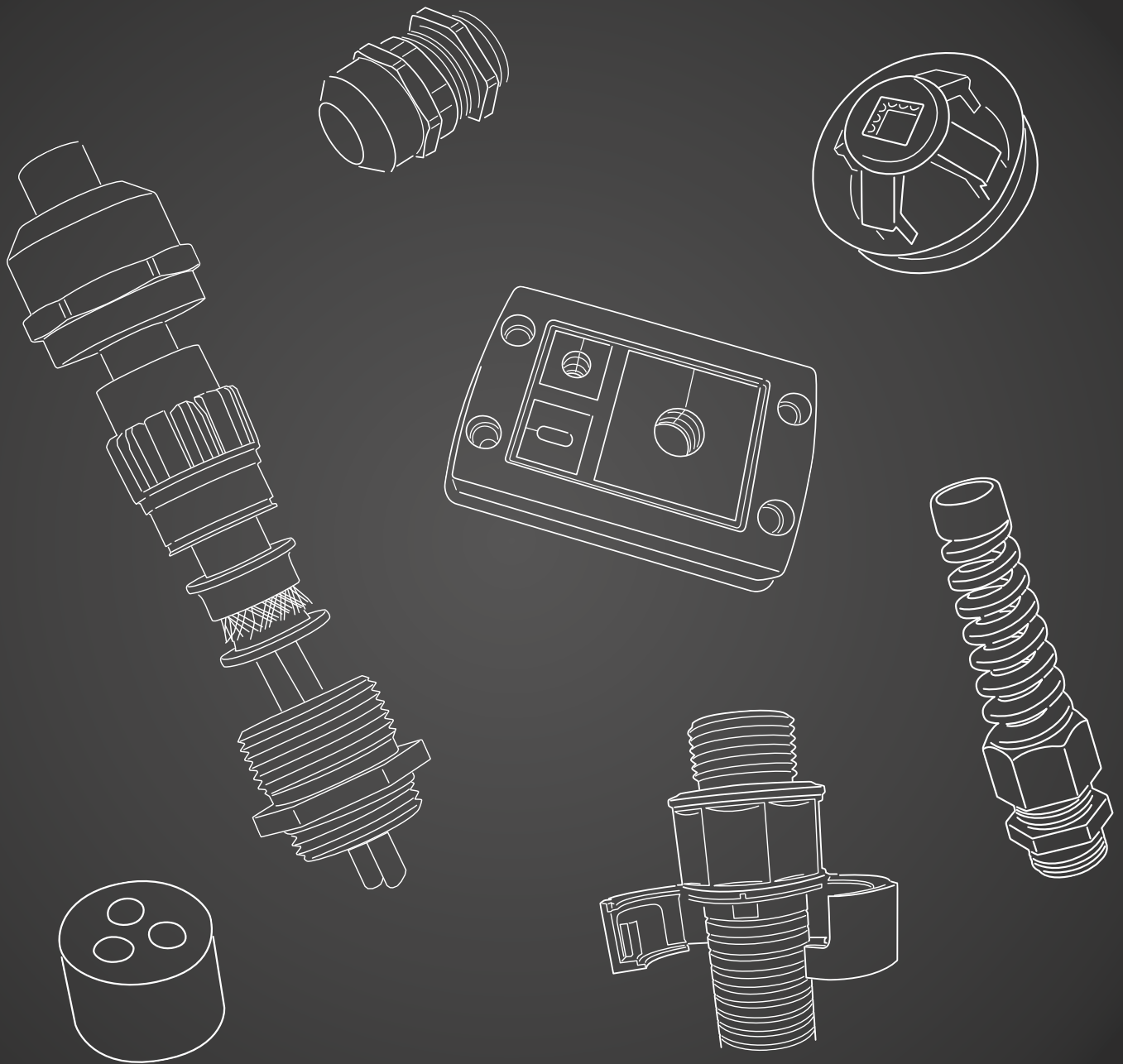

WISKA Hoppmann GmbH

Kisdorfer Weg 28
24568 Kaltenkirchen
Germany

☎ +49-4191-508-0
📠 +49-4191-508-129

contact@wiska.de
www.wiska.com